

## Was fehlt?



**Dieses Spiel schult folgende Bereiche: Reaktion, Konzentration, optische Wahrnehmung, sprachliche Kompetenz und Mengenerfassung.**

### **Aufgabe:**

**Das Kind / die Kinder sollen die fehlende Figur finden.**

**Große Karte = Alle Symbole / Figuren vorhanden**

**Kleine Karte = Ein Symbol / eine Figur fehlt**

### **Anleitung zur Herstellung:**

- **Auf festem Papier ausdrucken**
- **Laminieren**

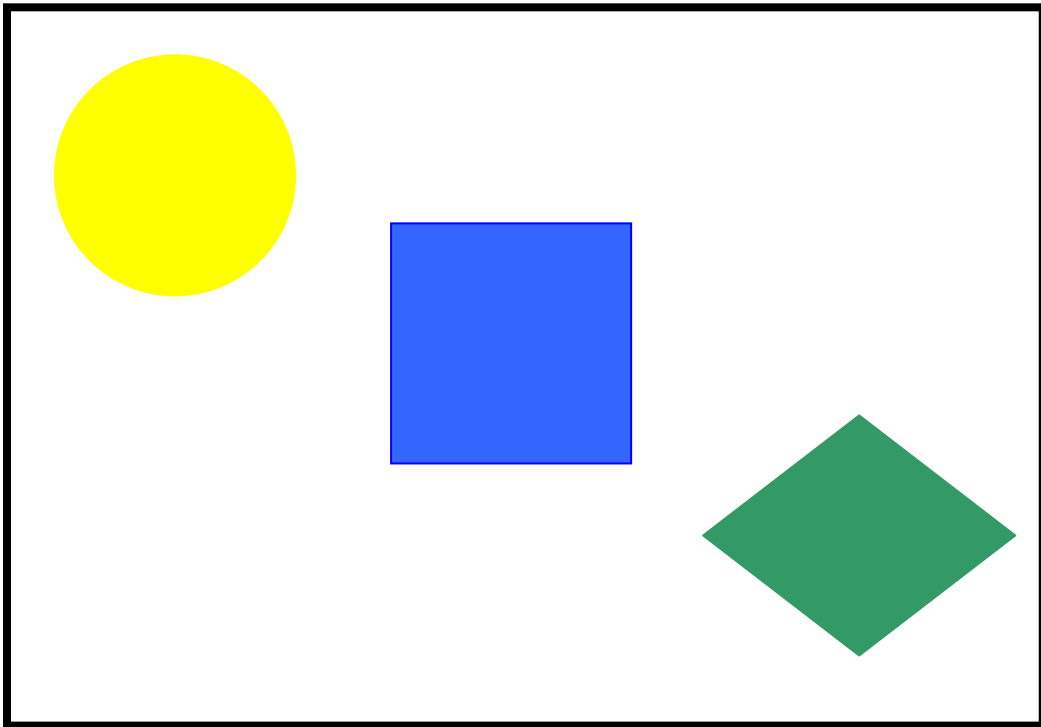
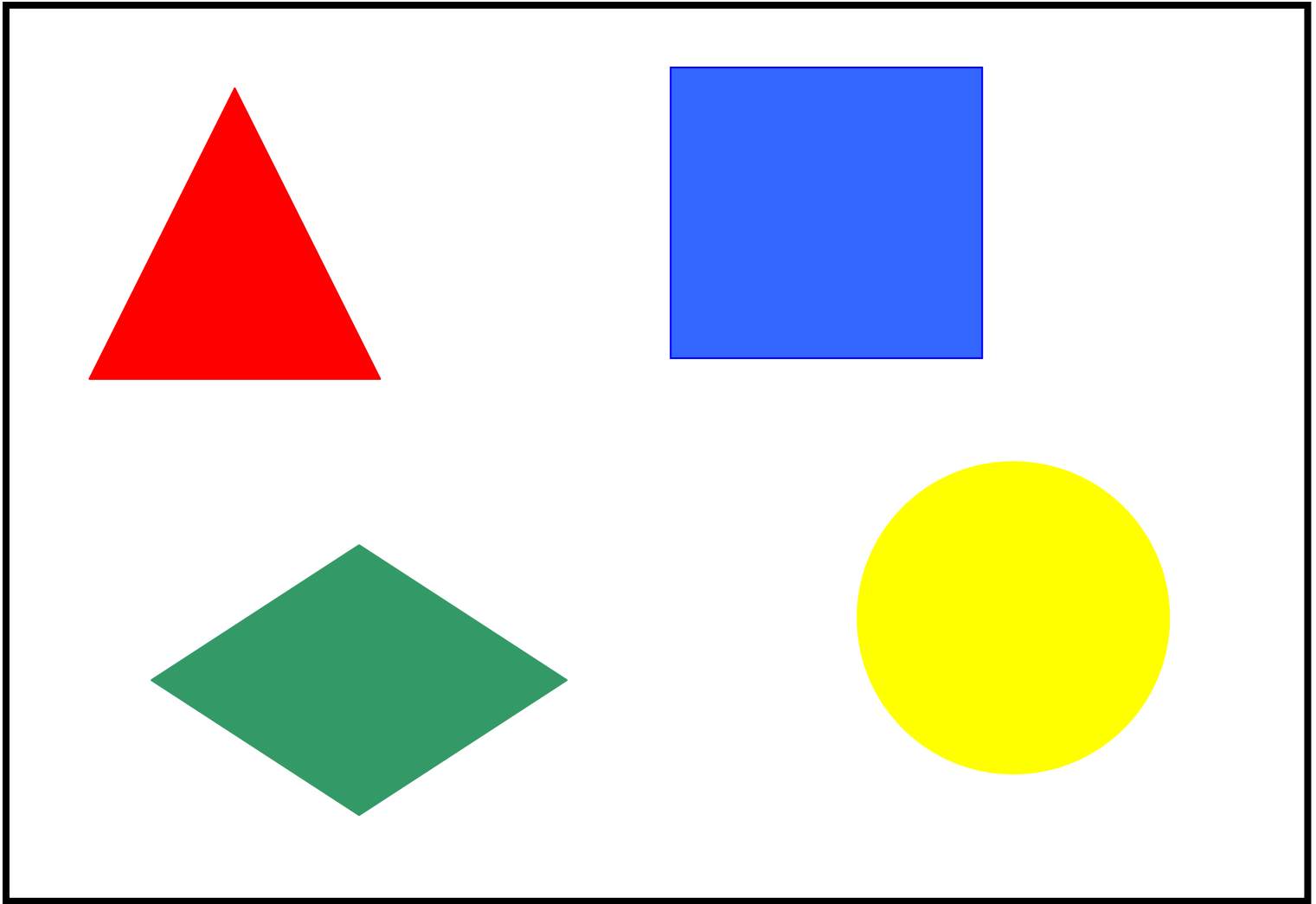

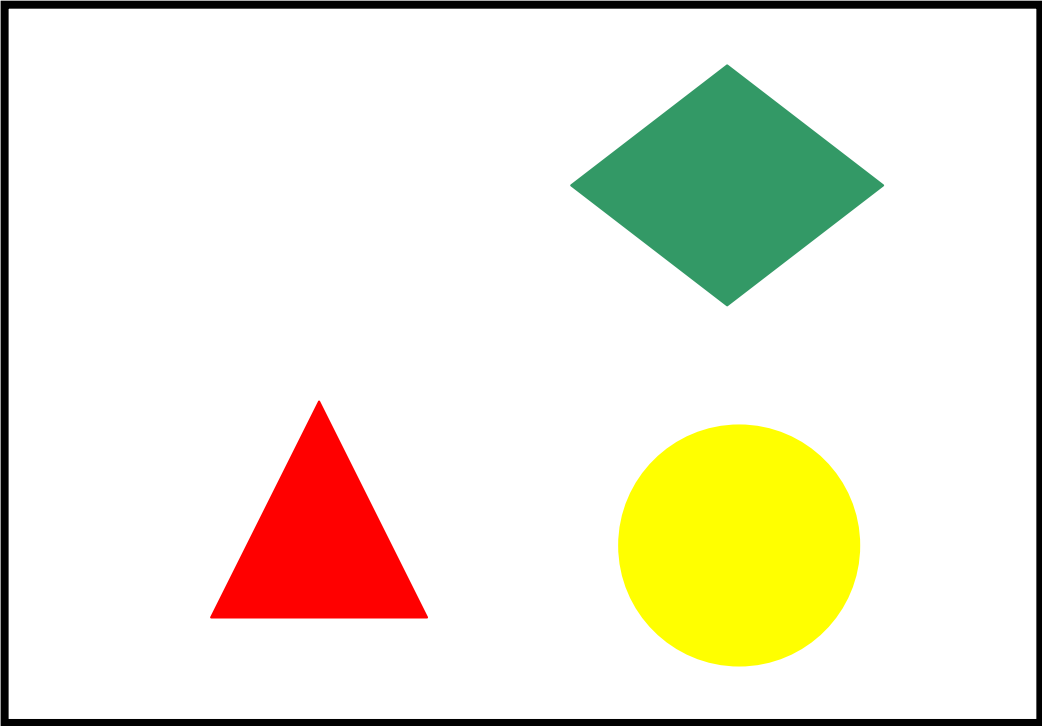
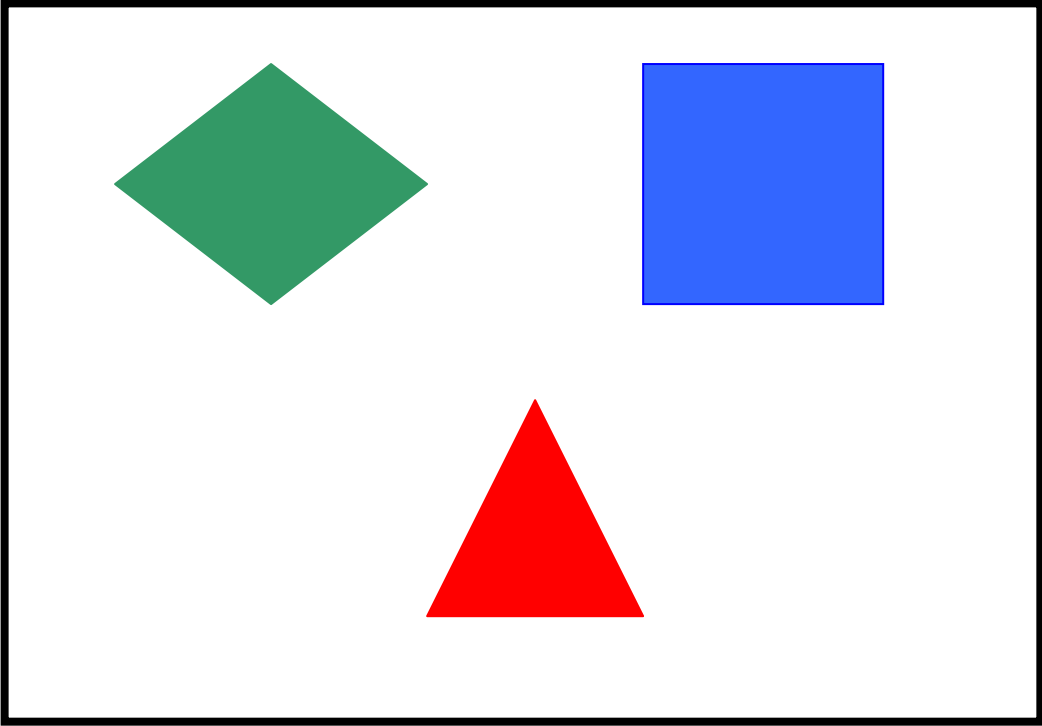

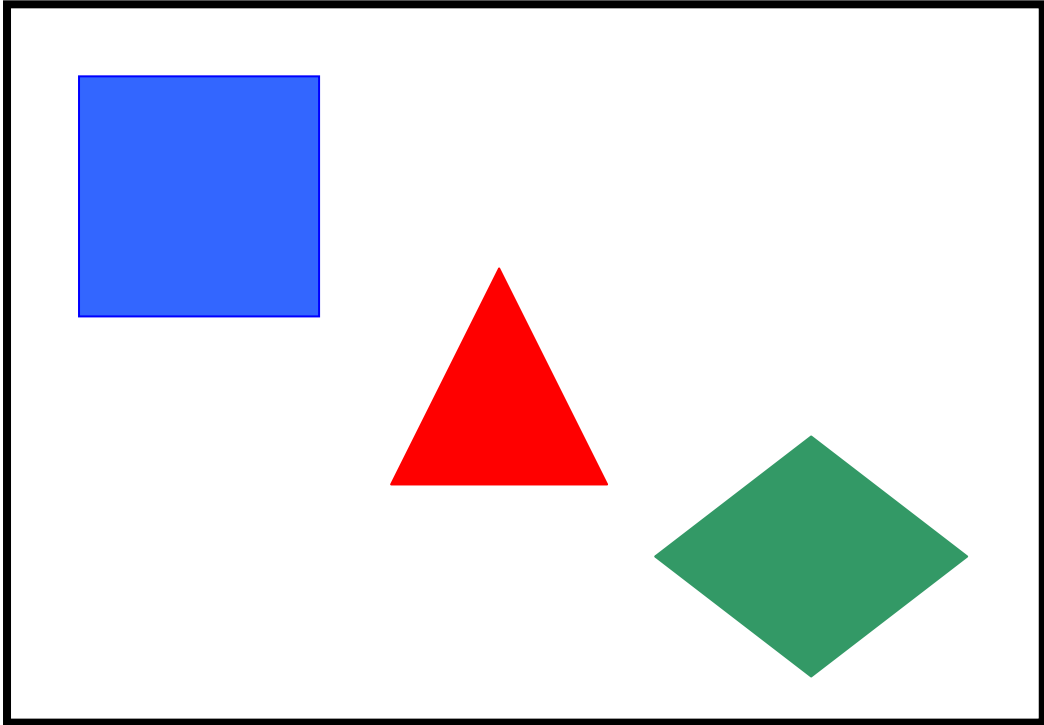
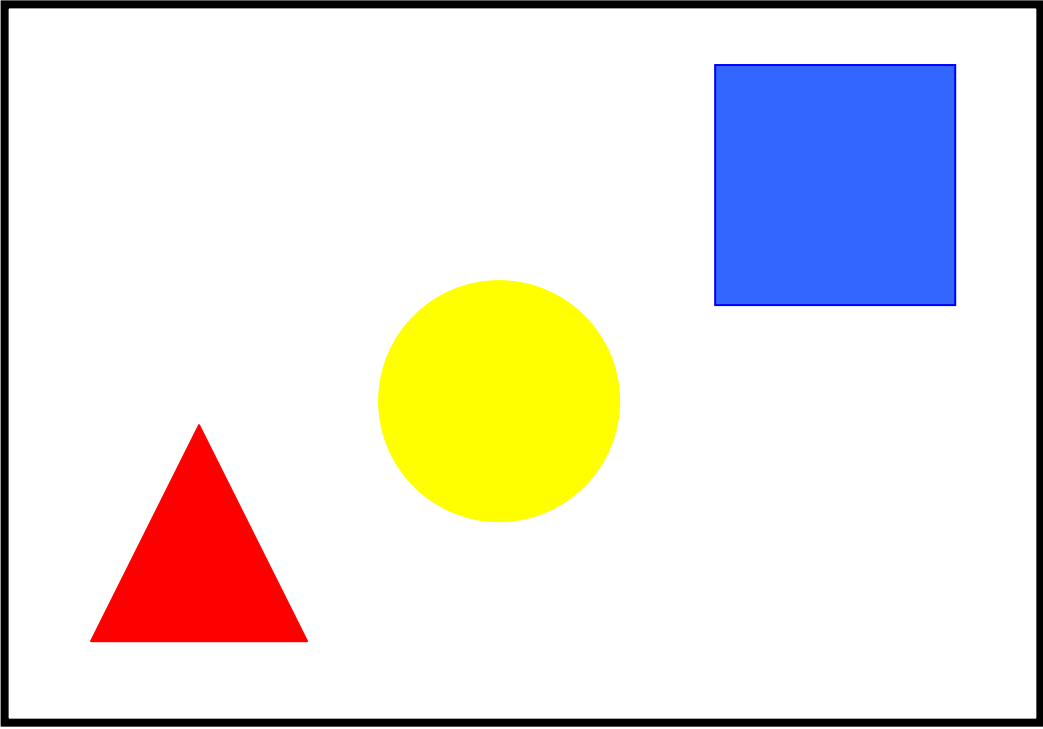

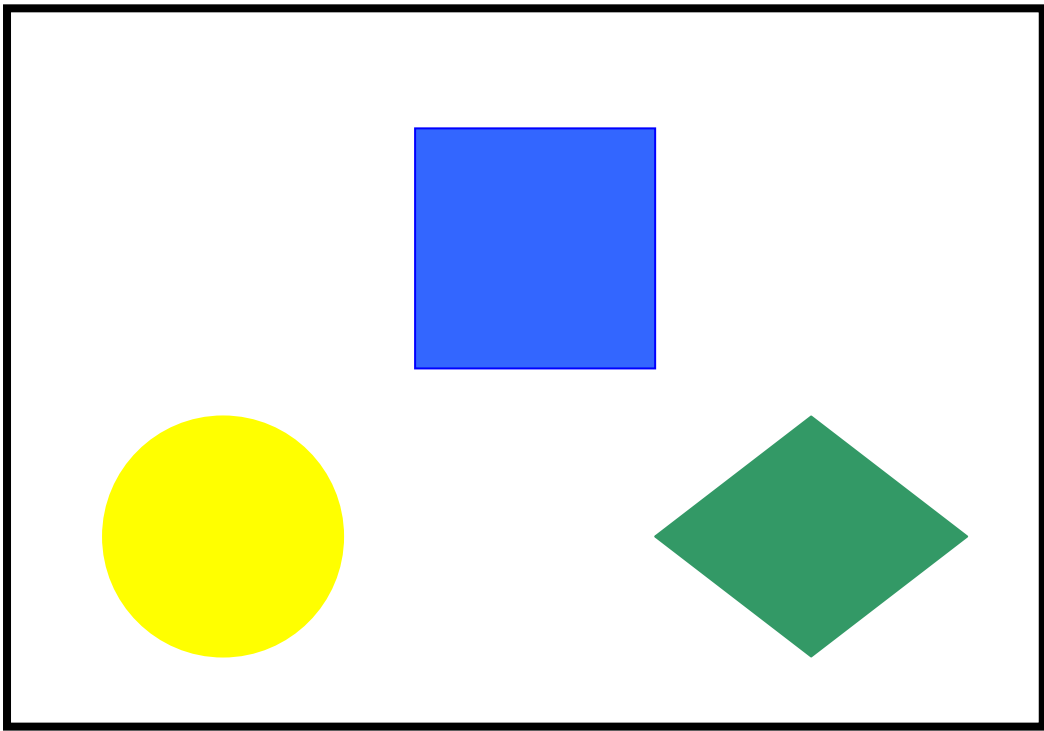
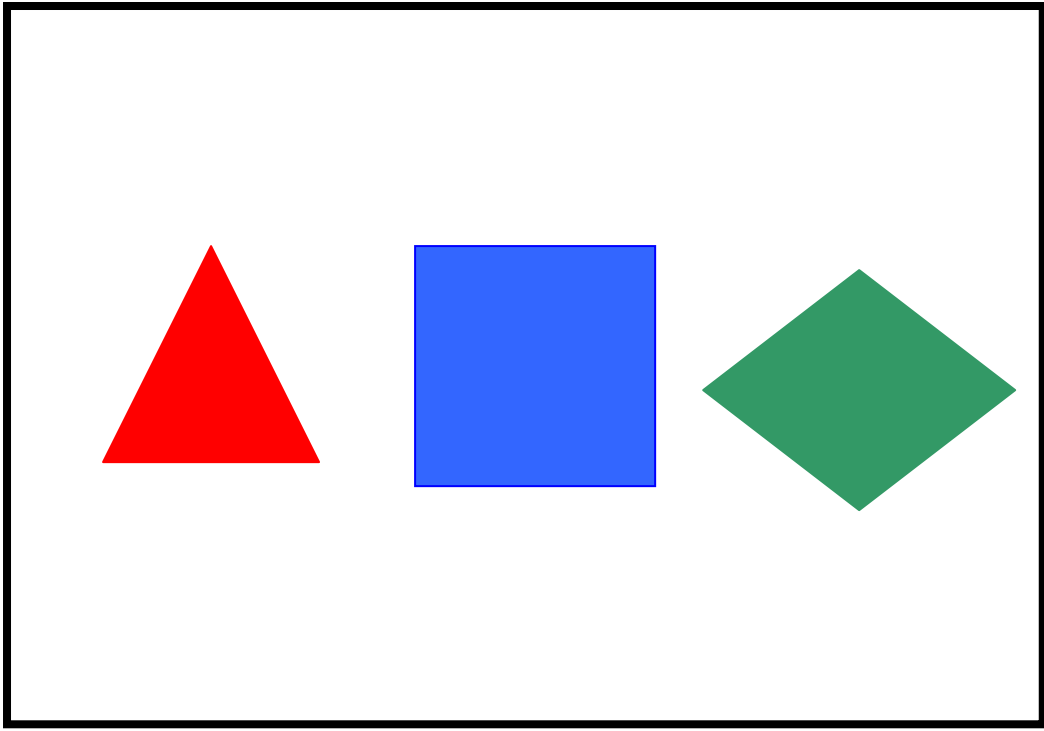

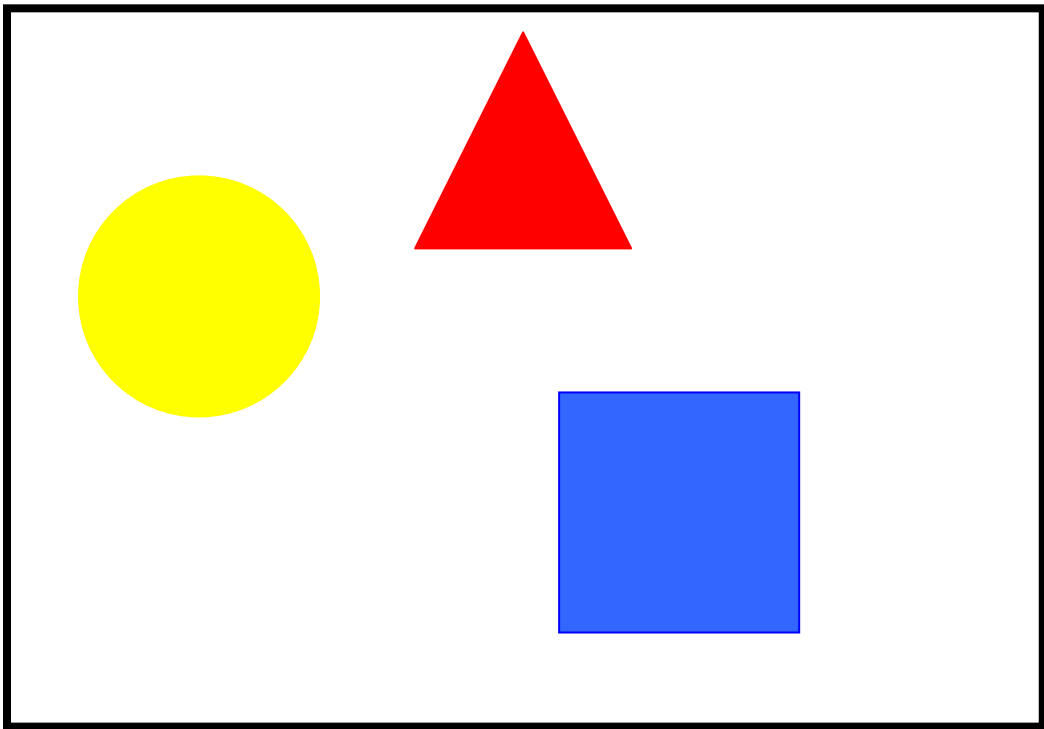
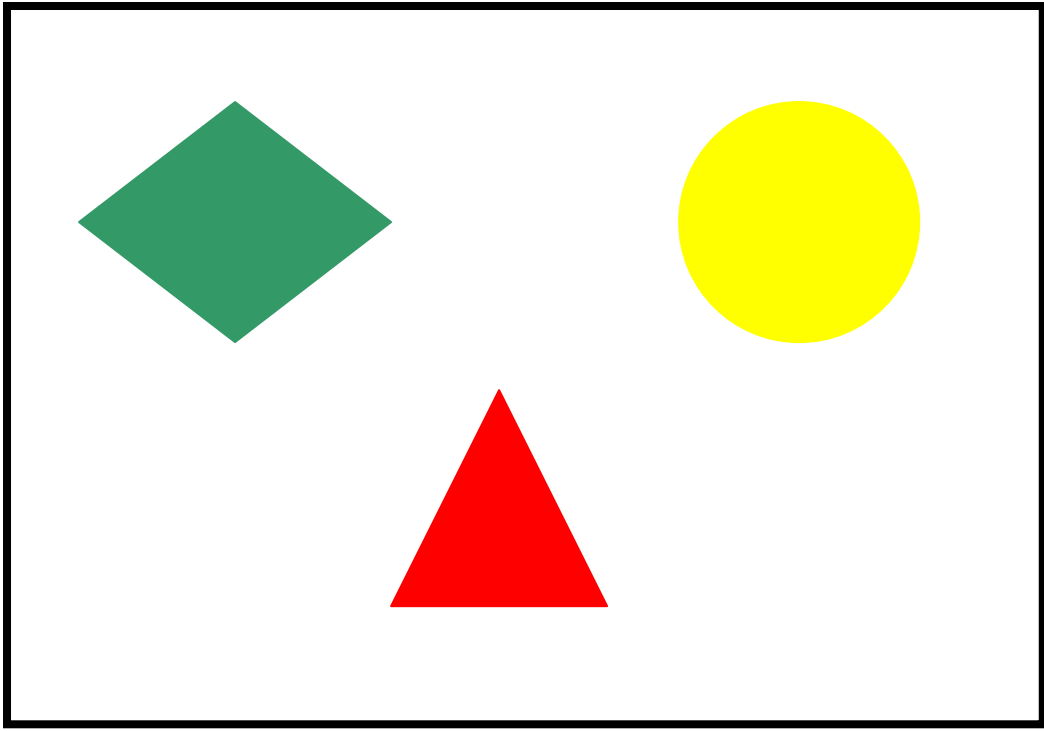

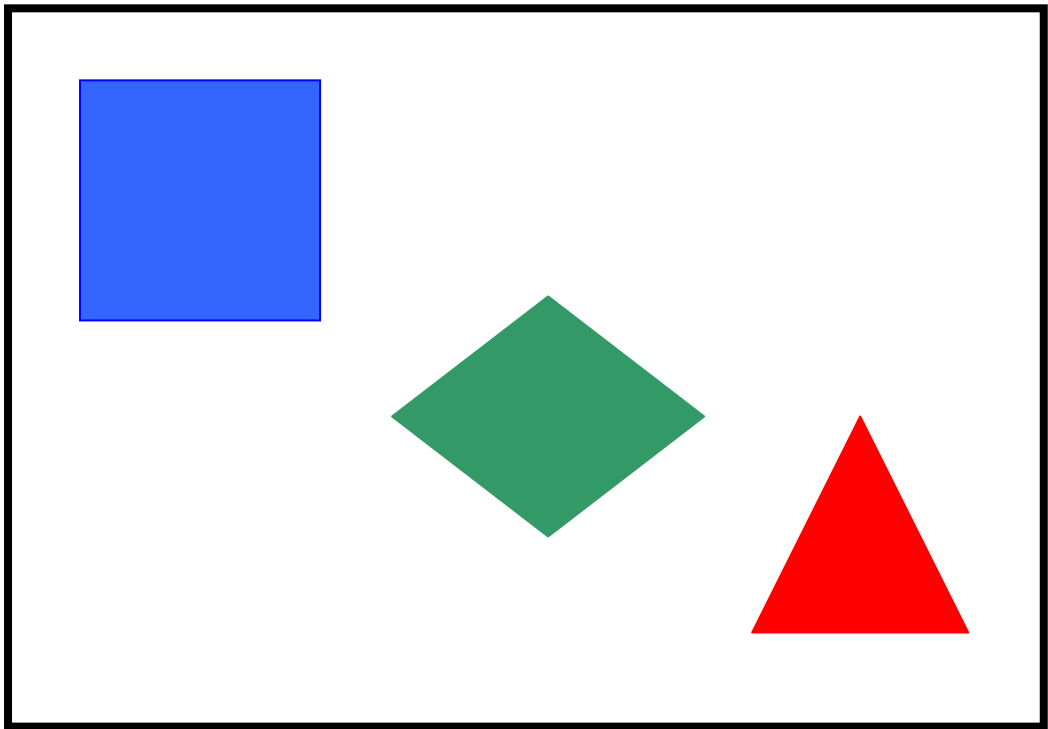
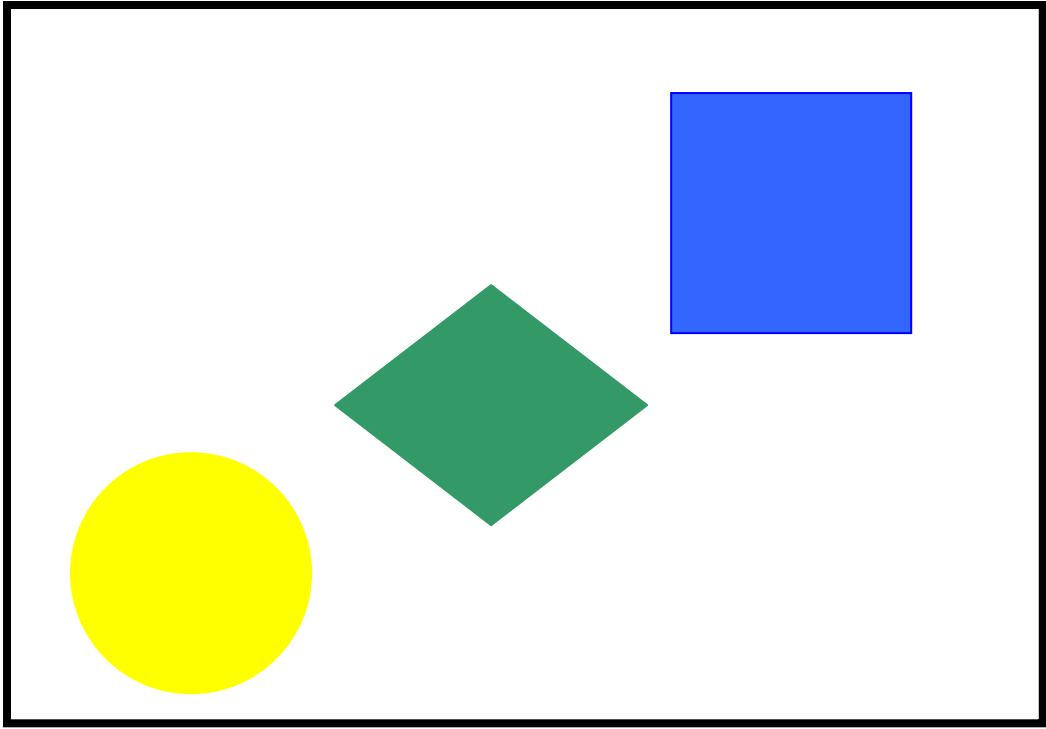

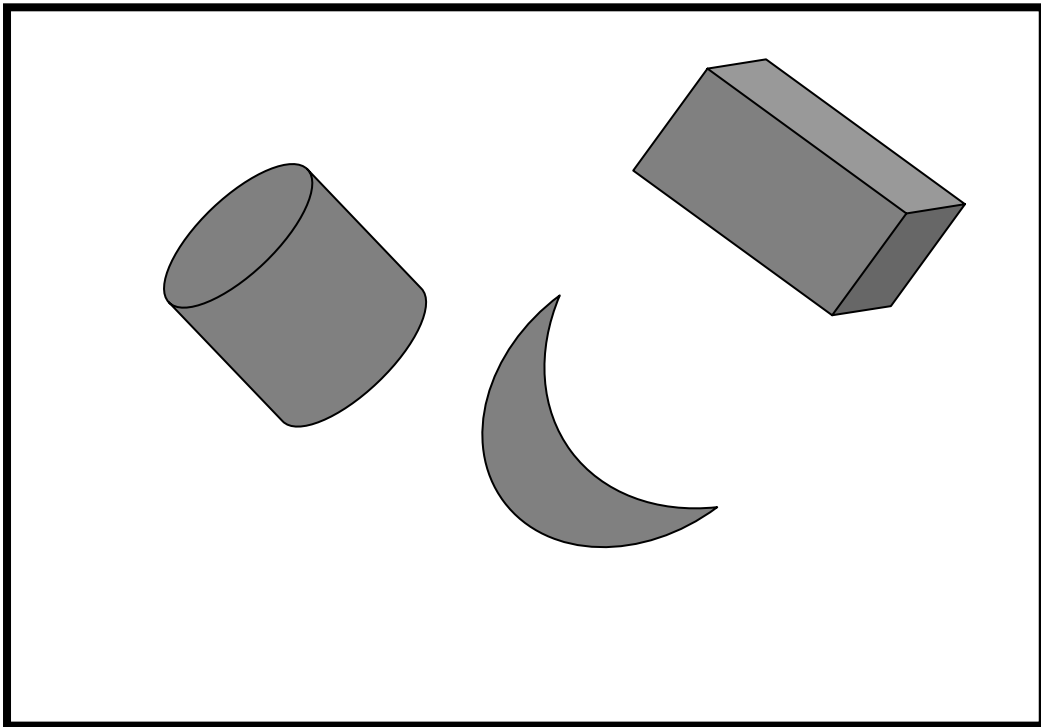
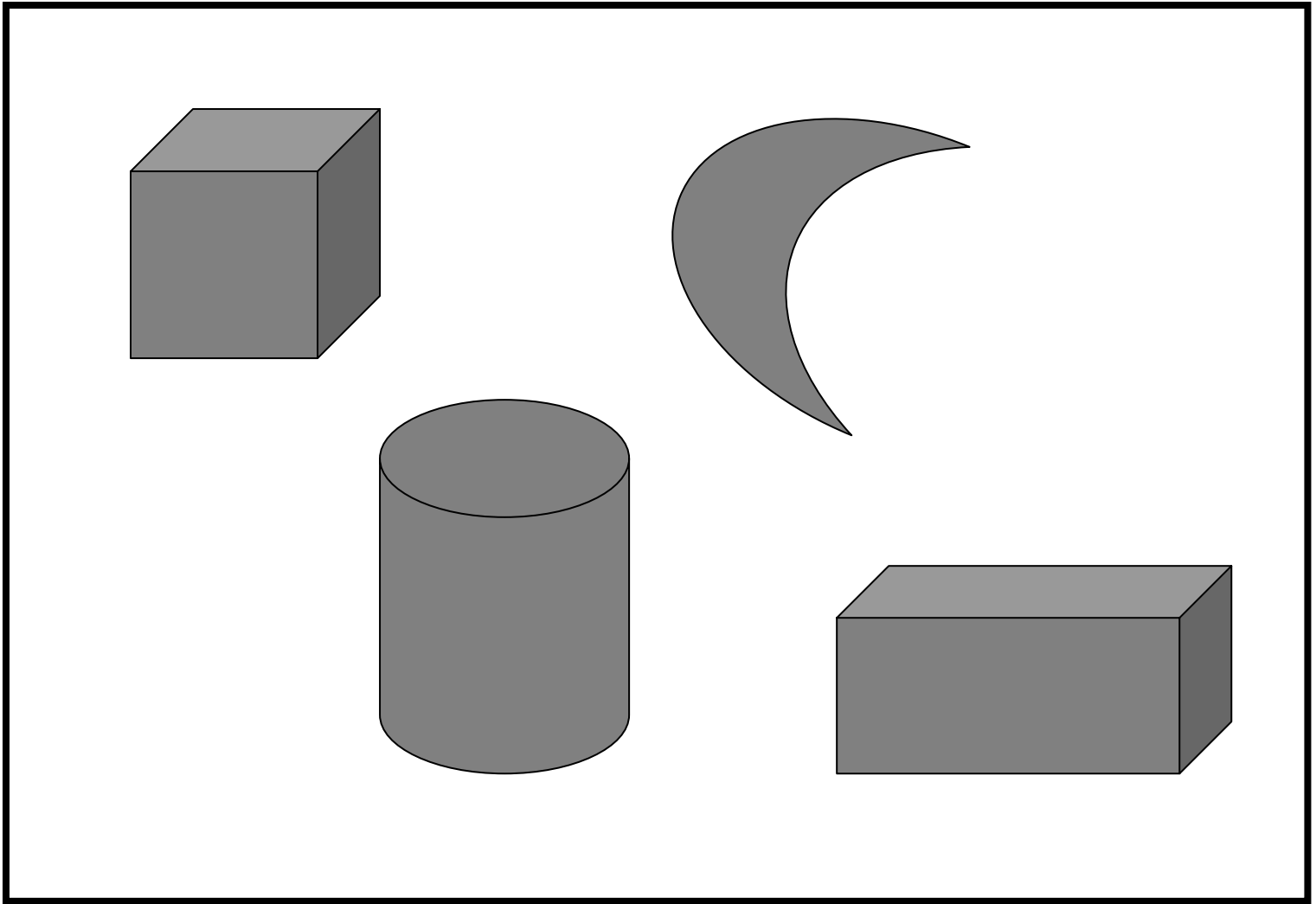



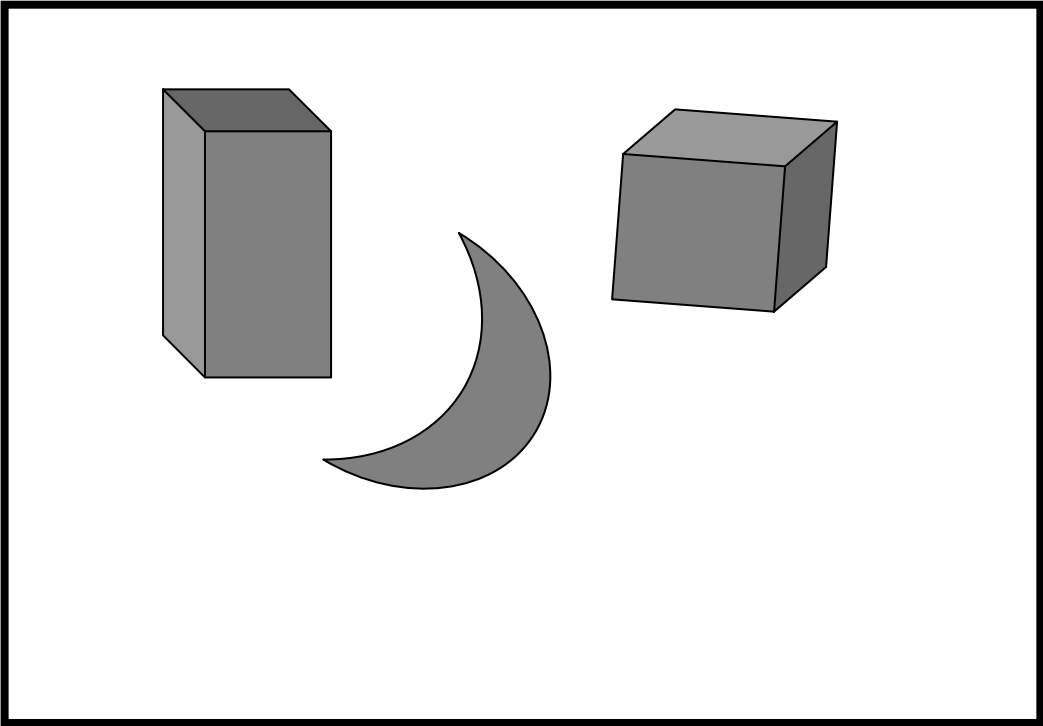
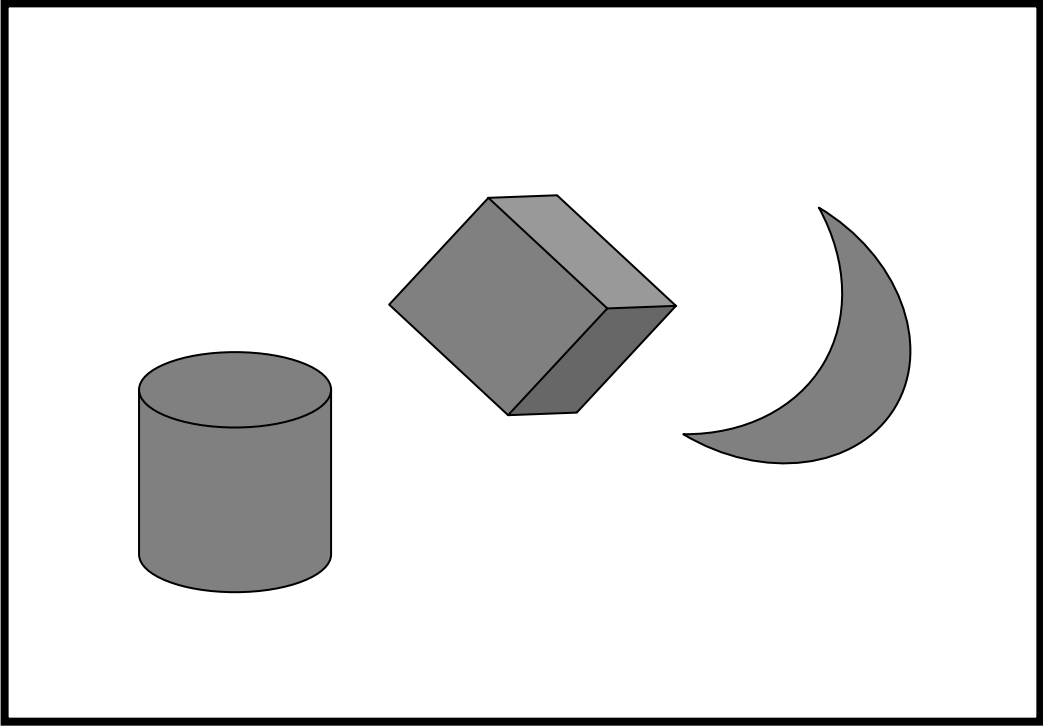

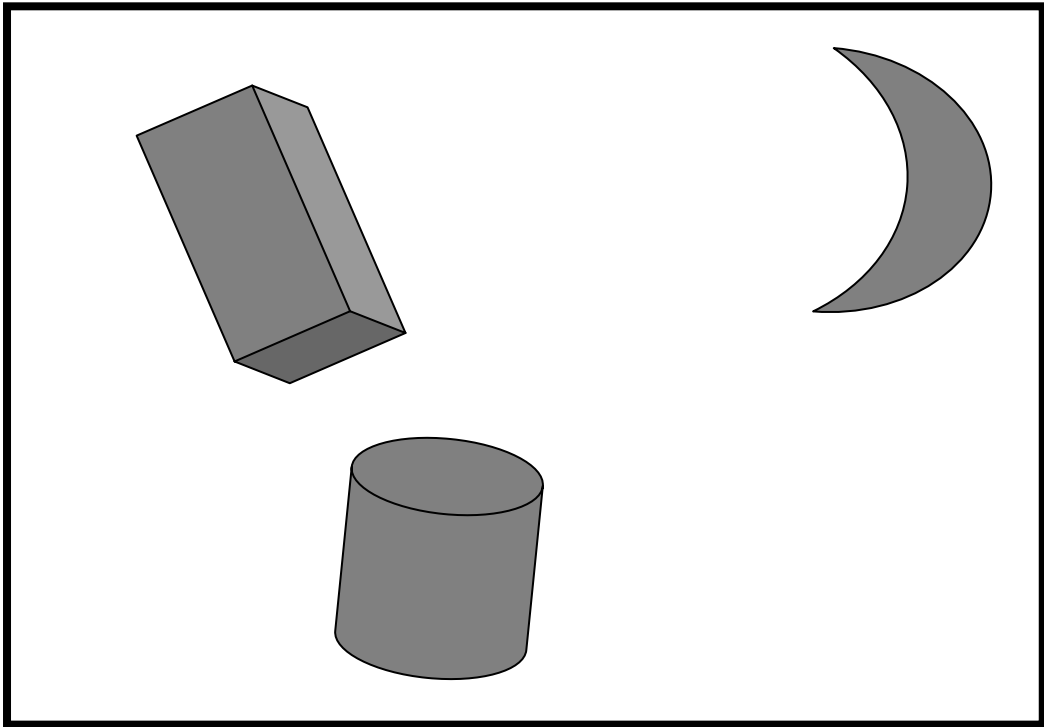
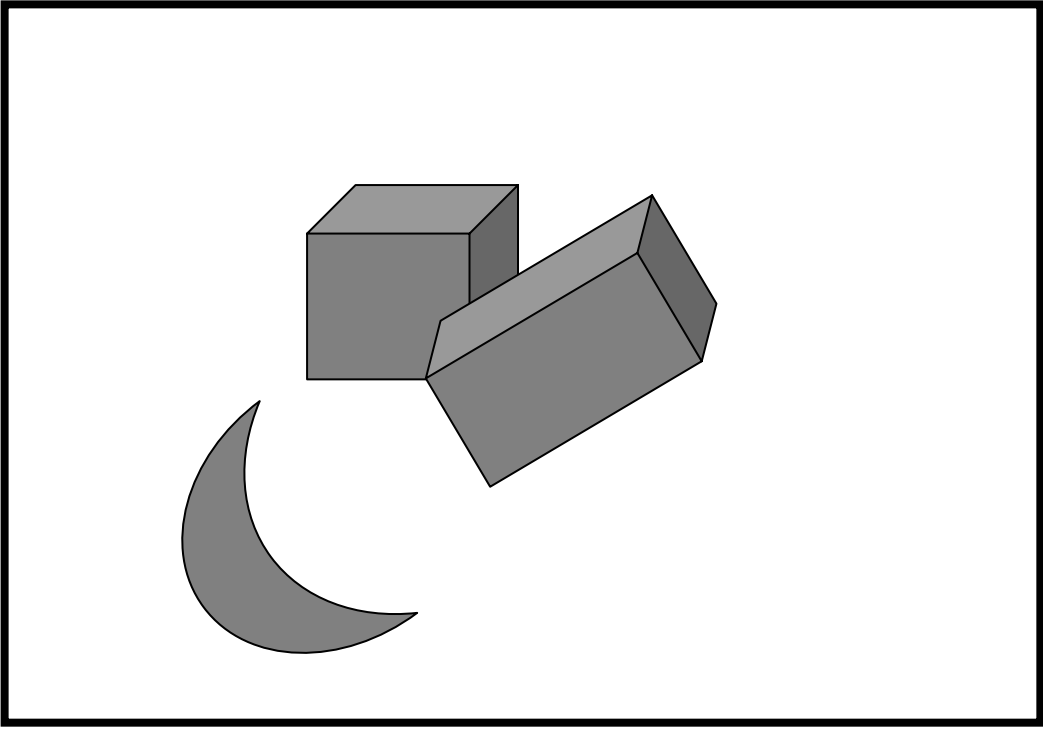

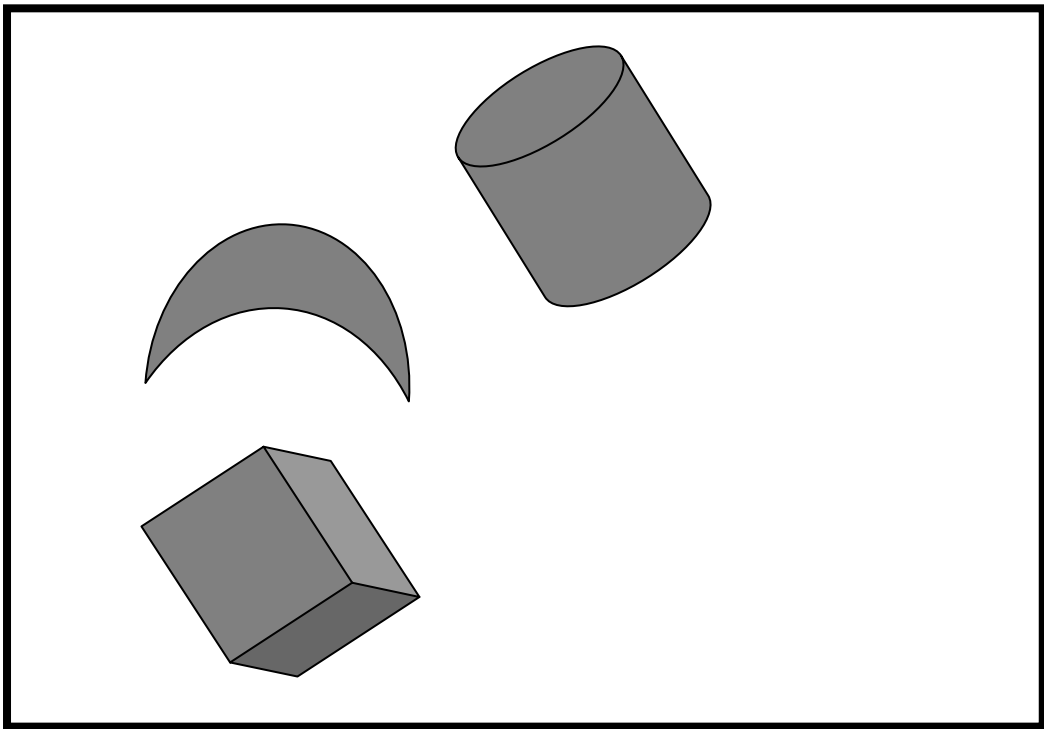
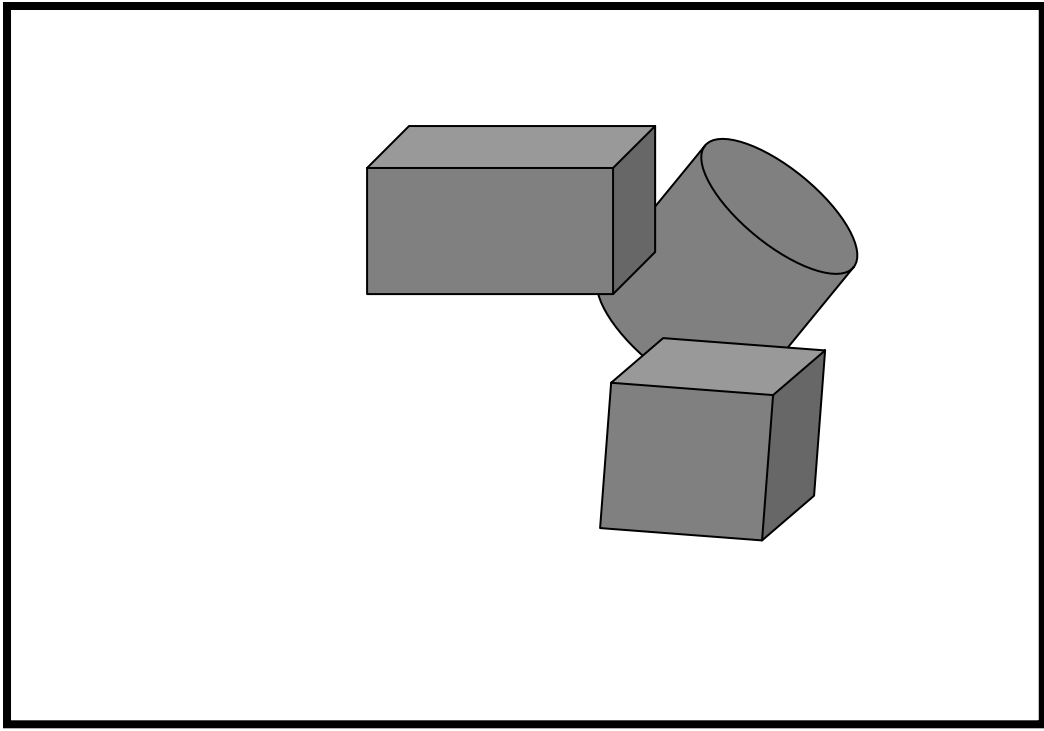

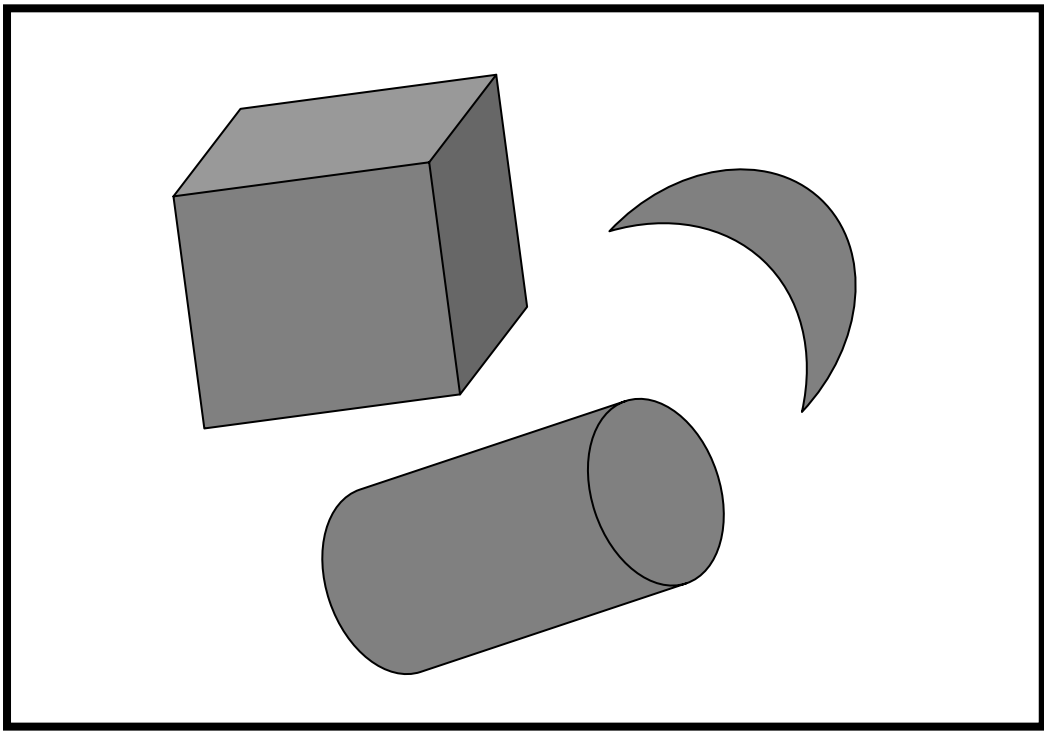
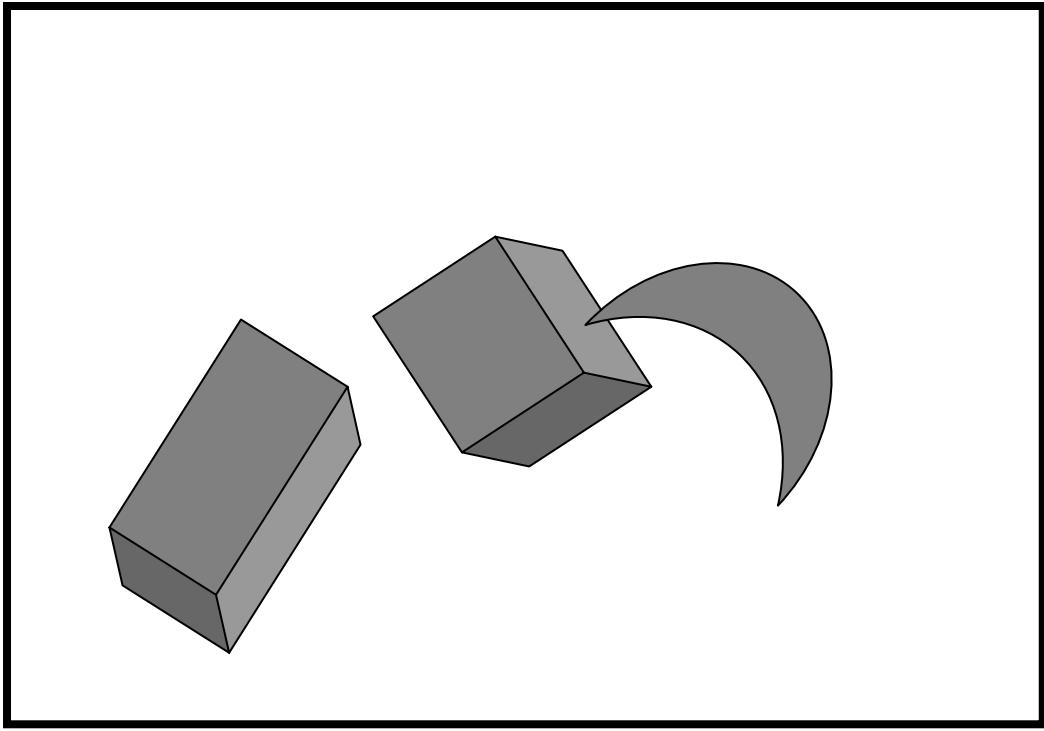

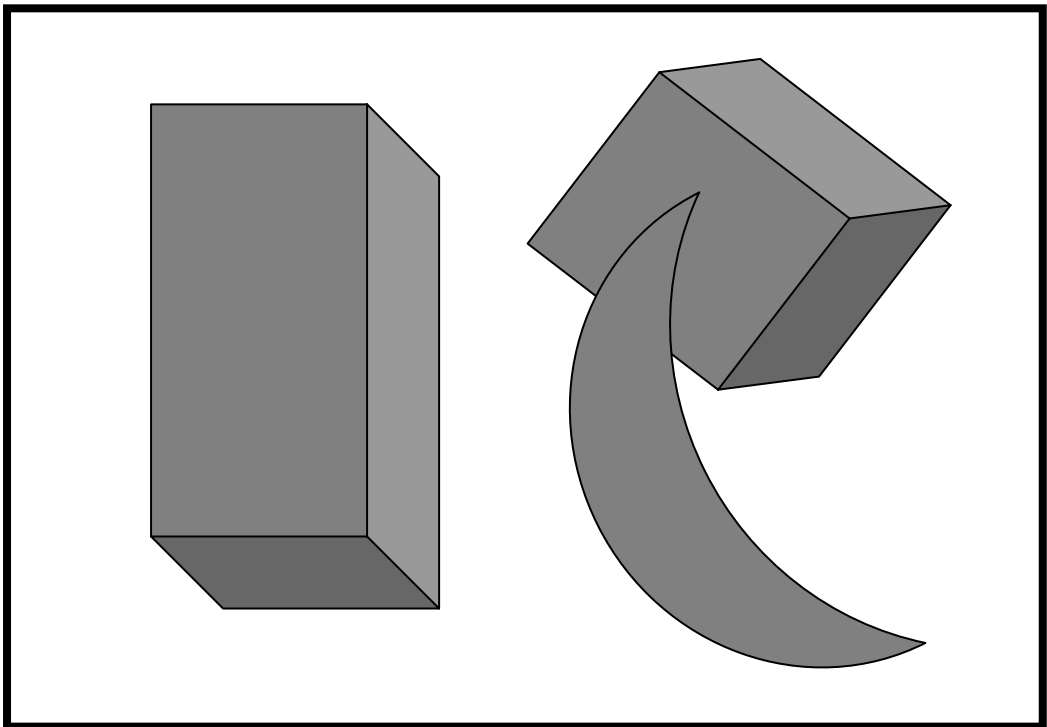
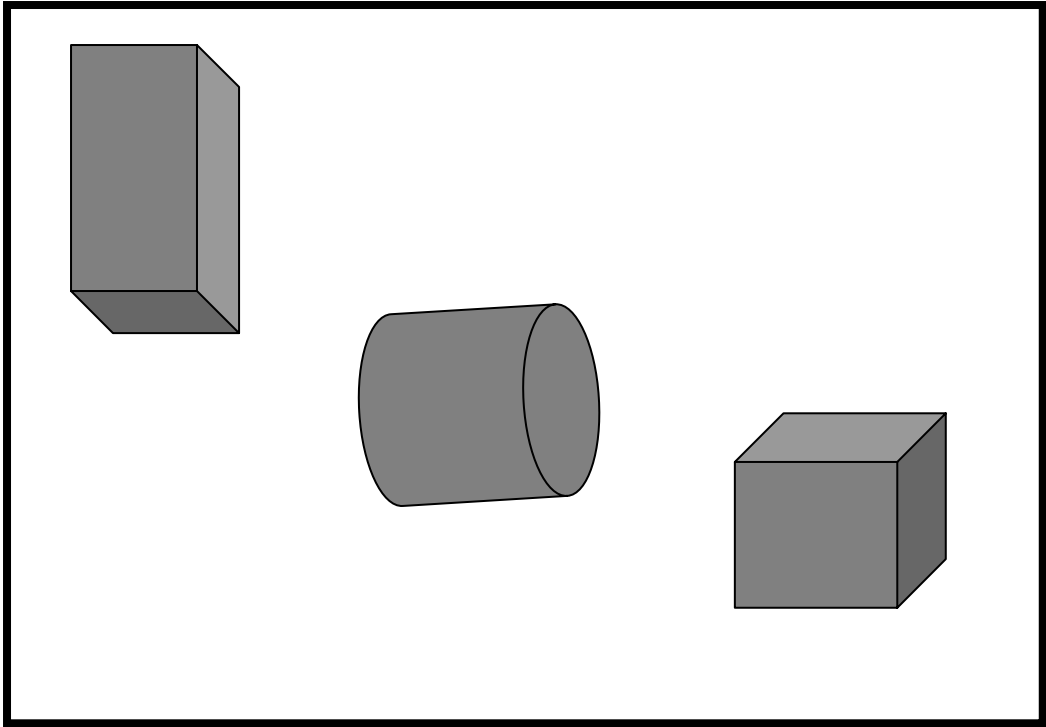

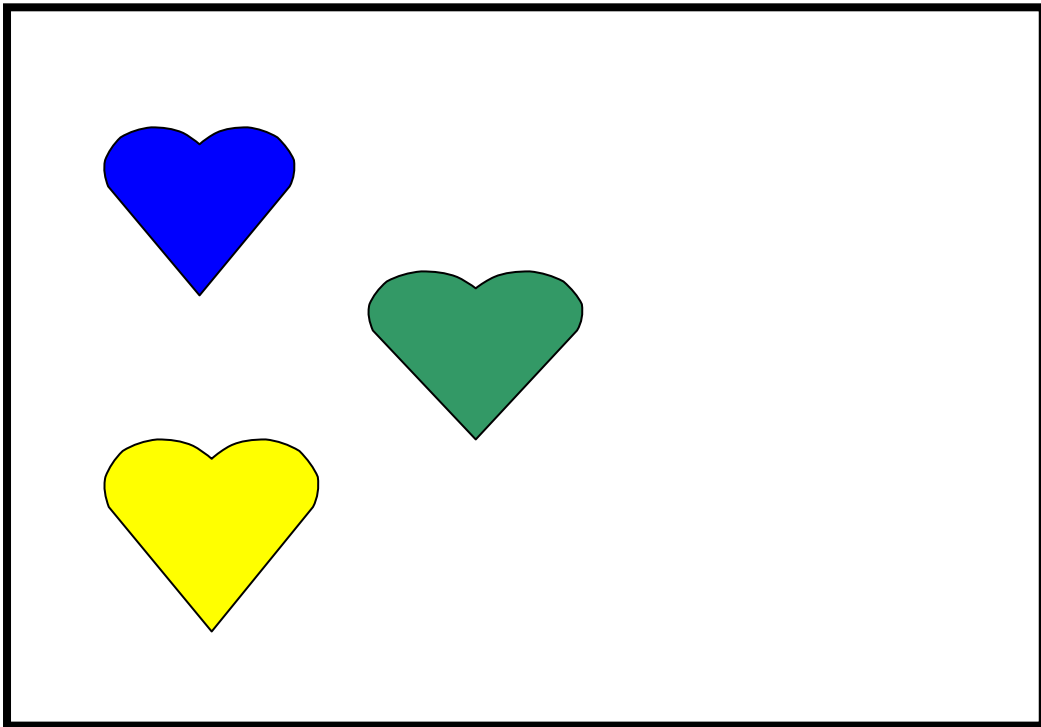
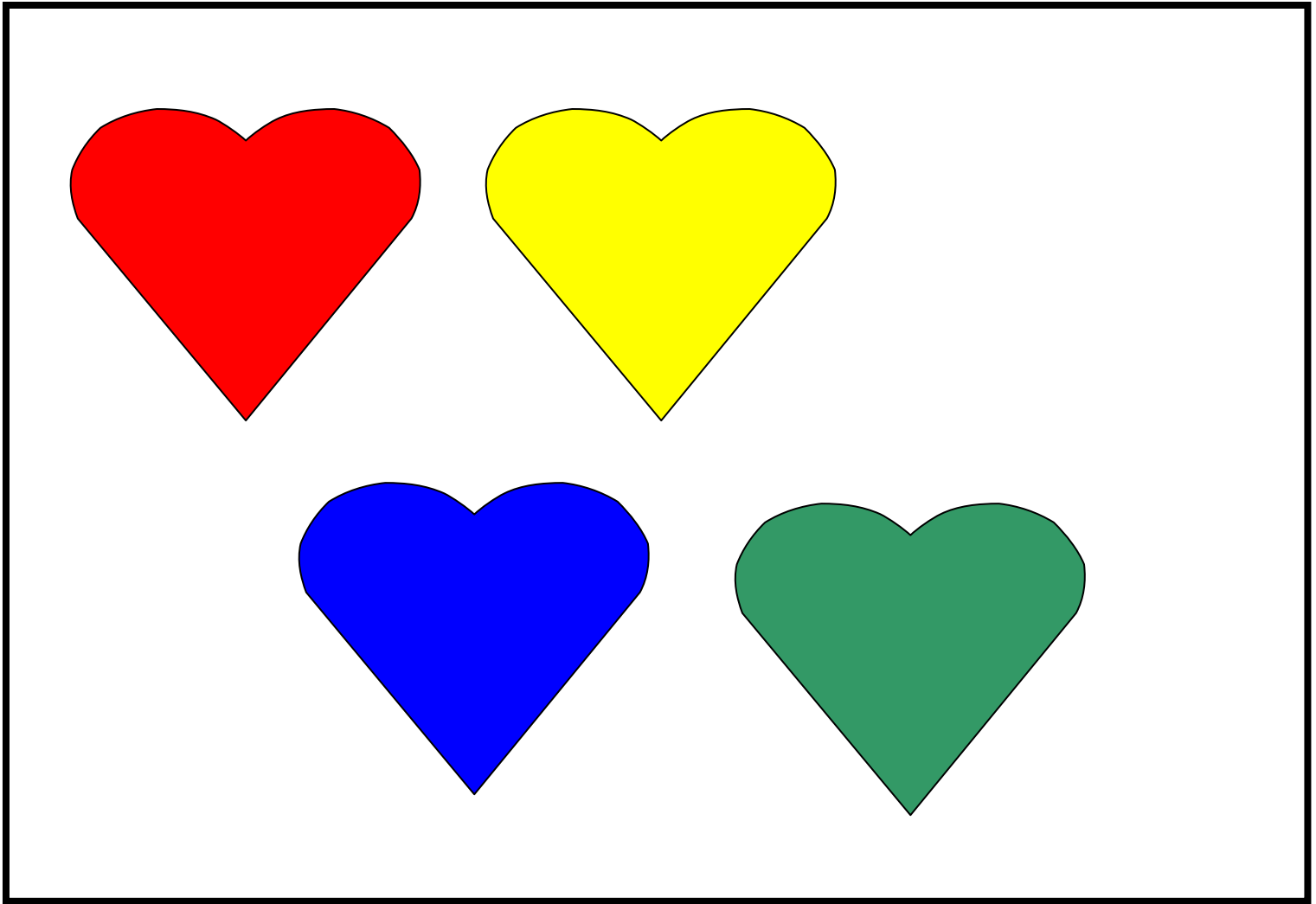

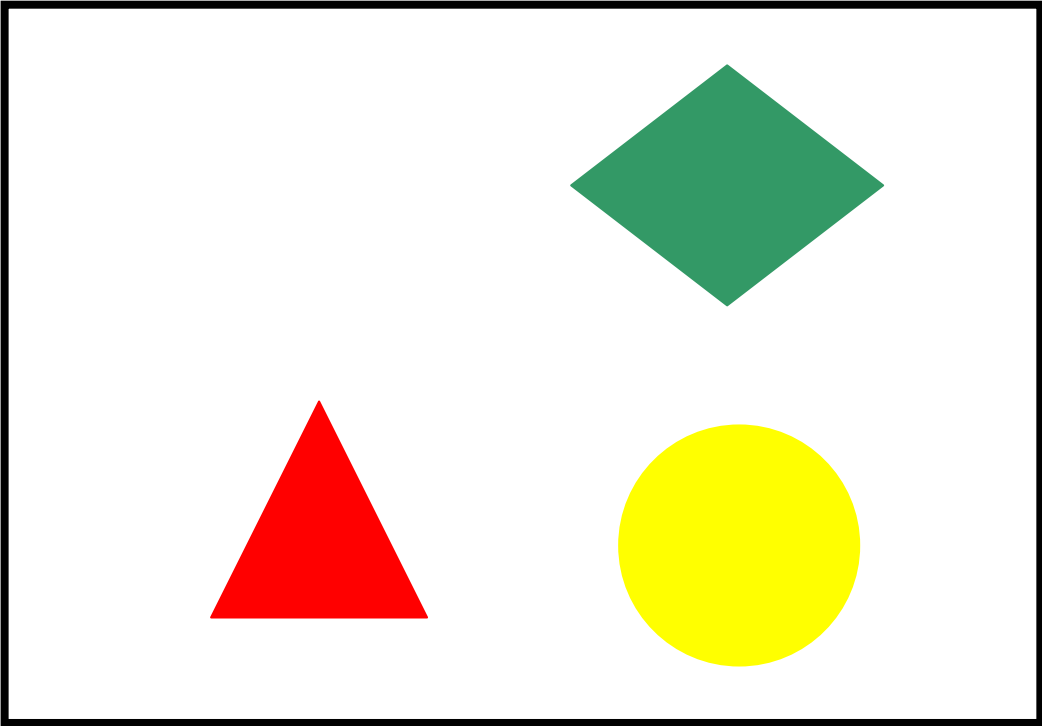
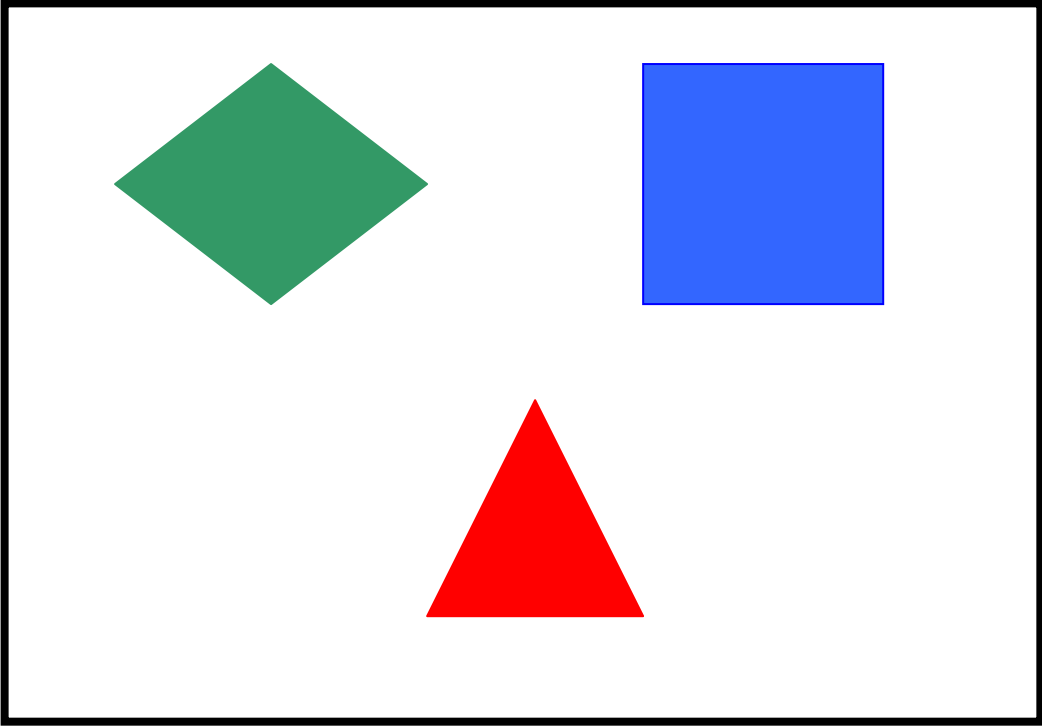

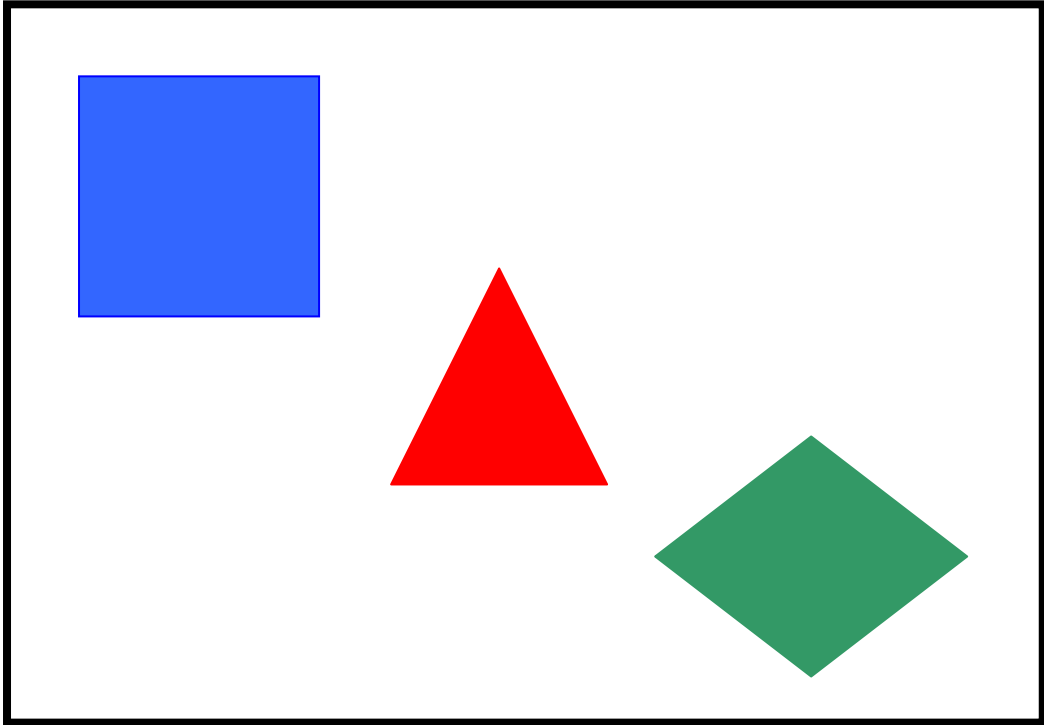
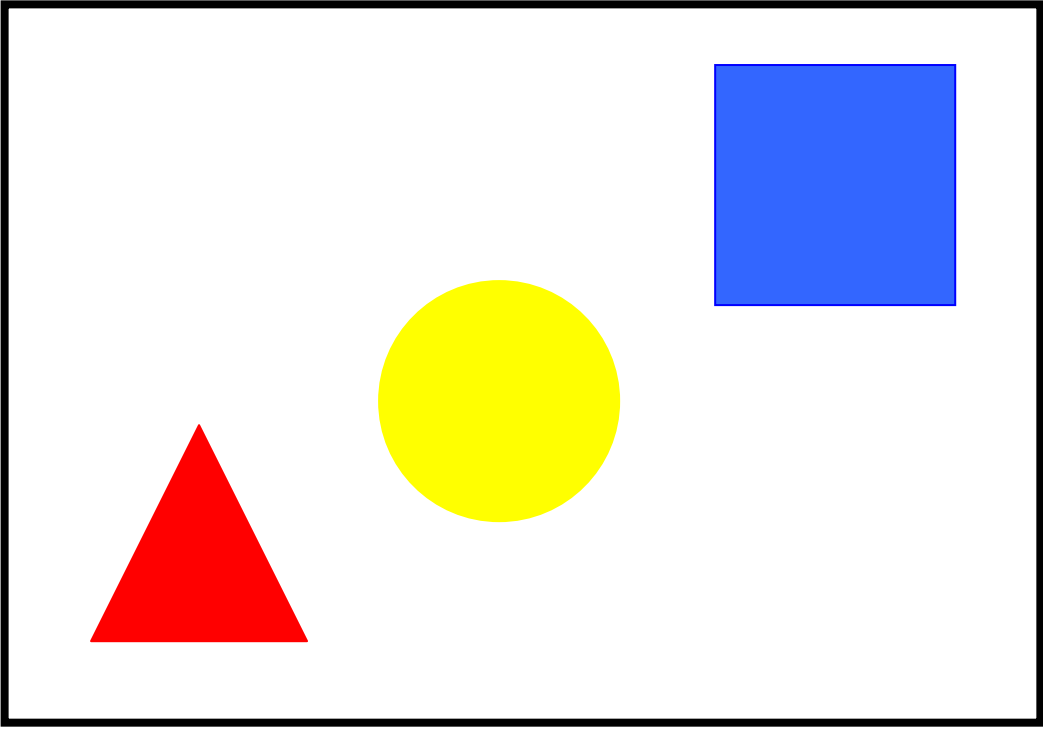



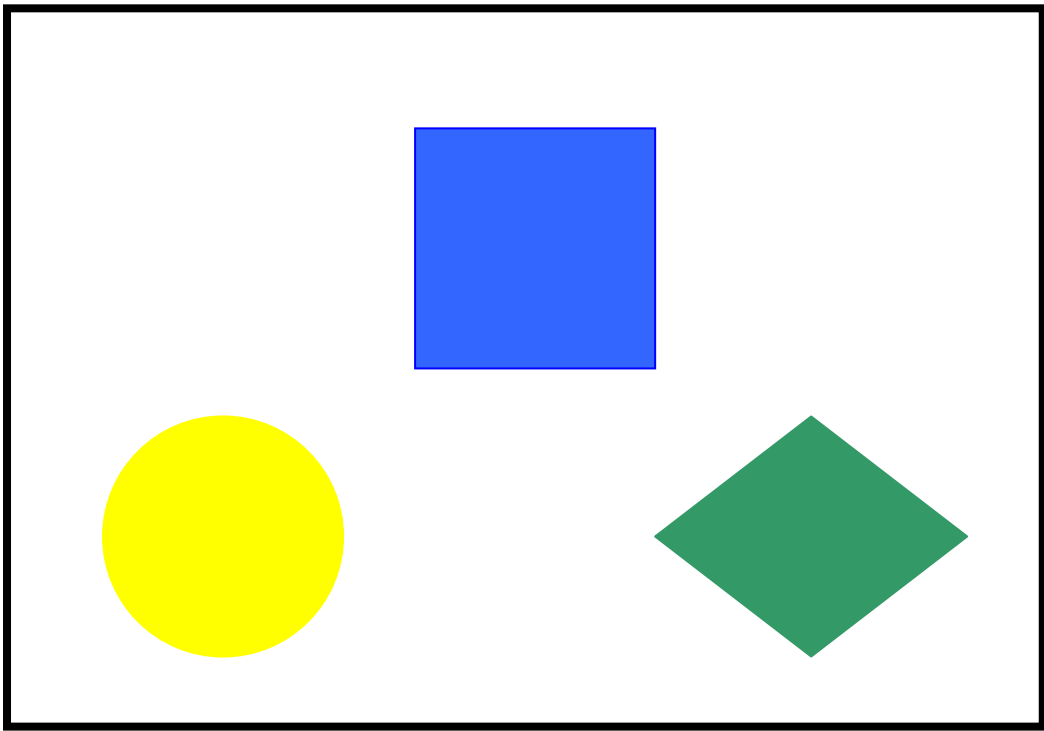
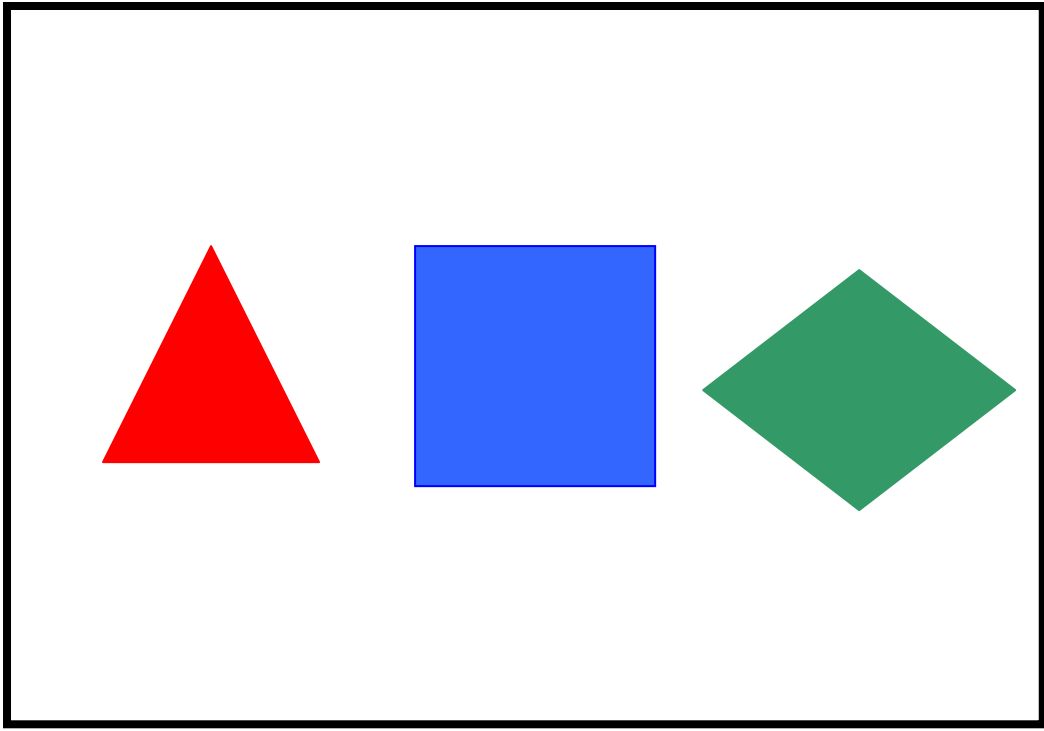

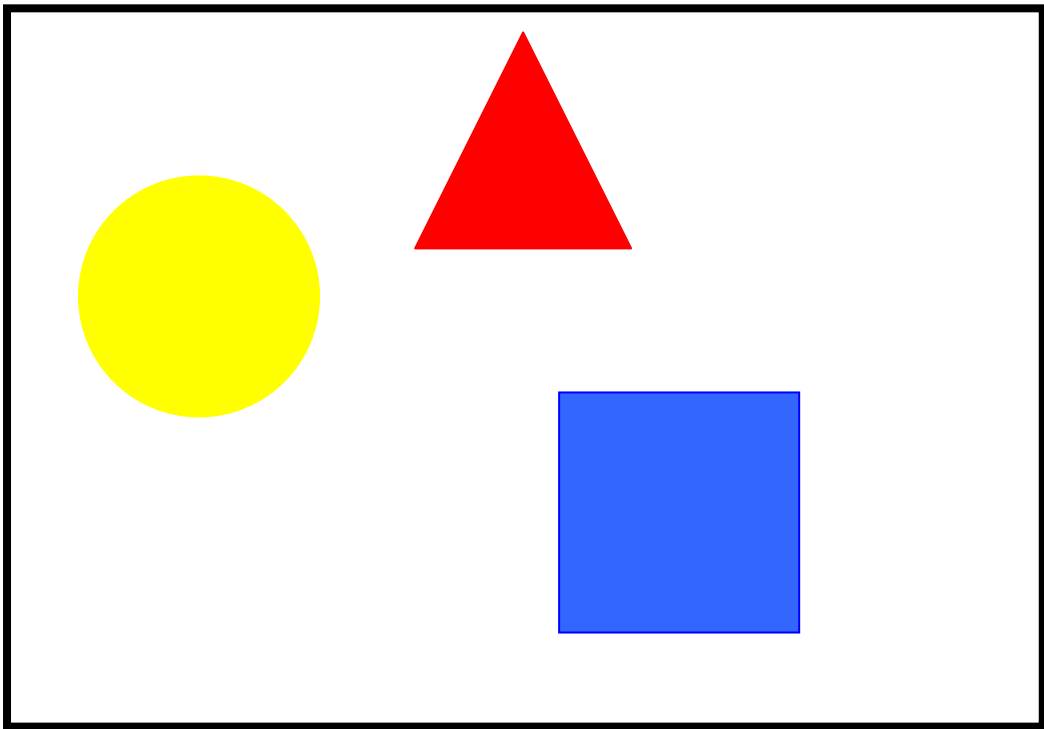
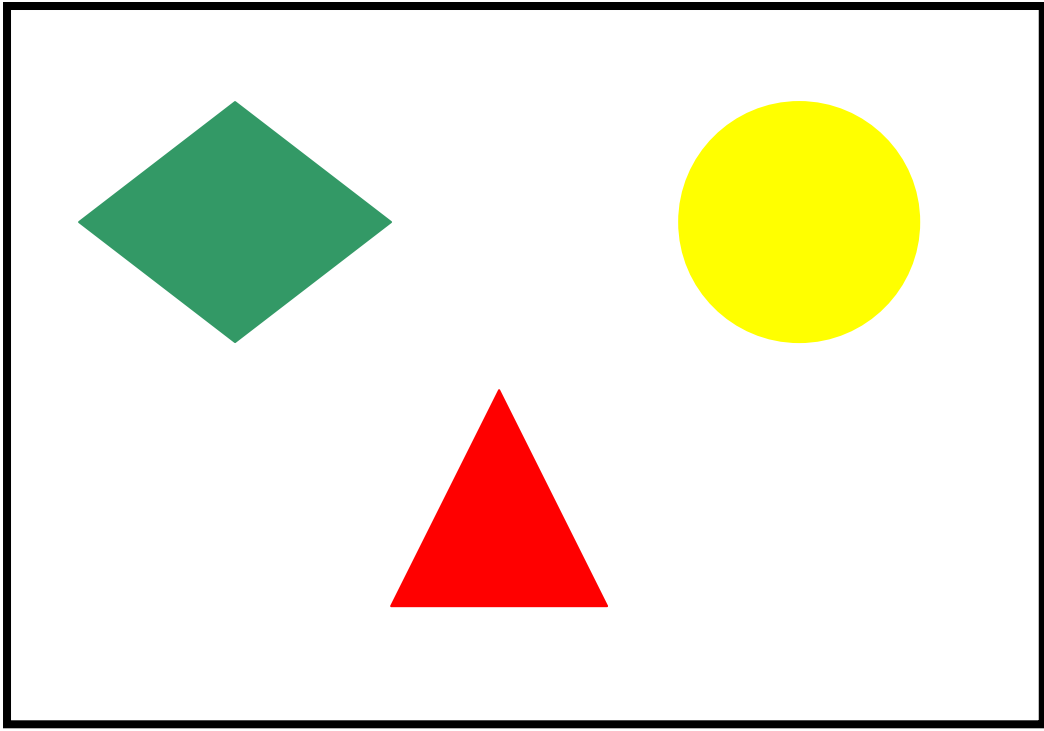

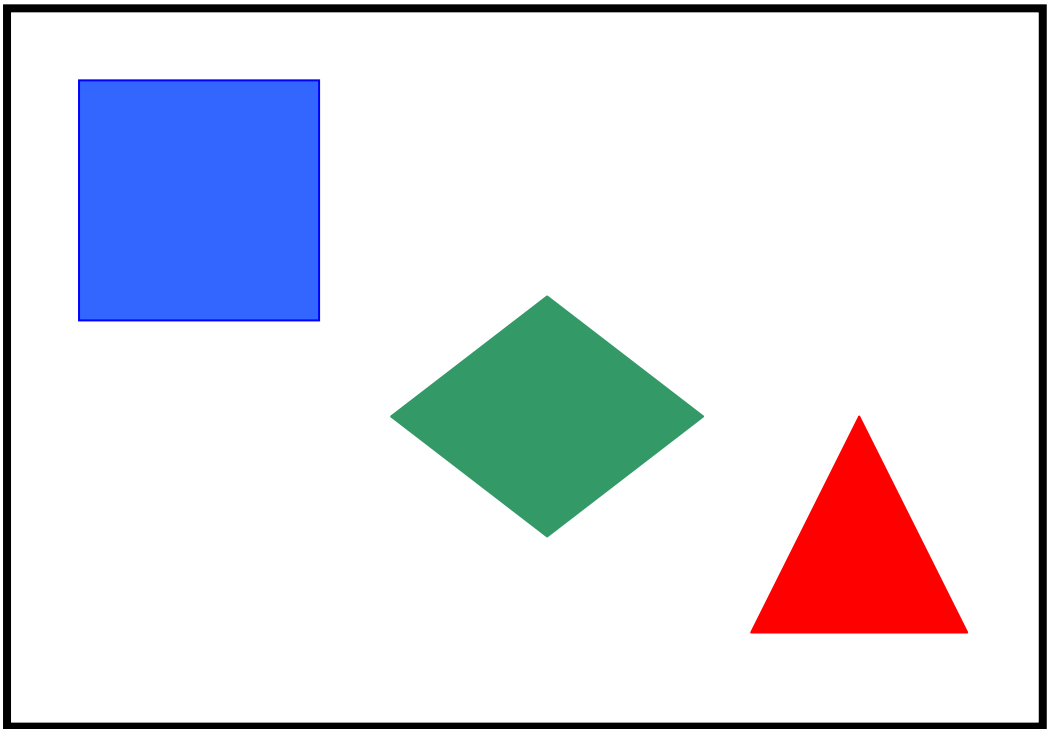
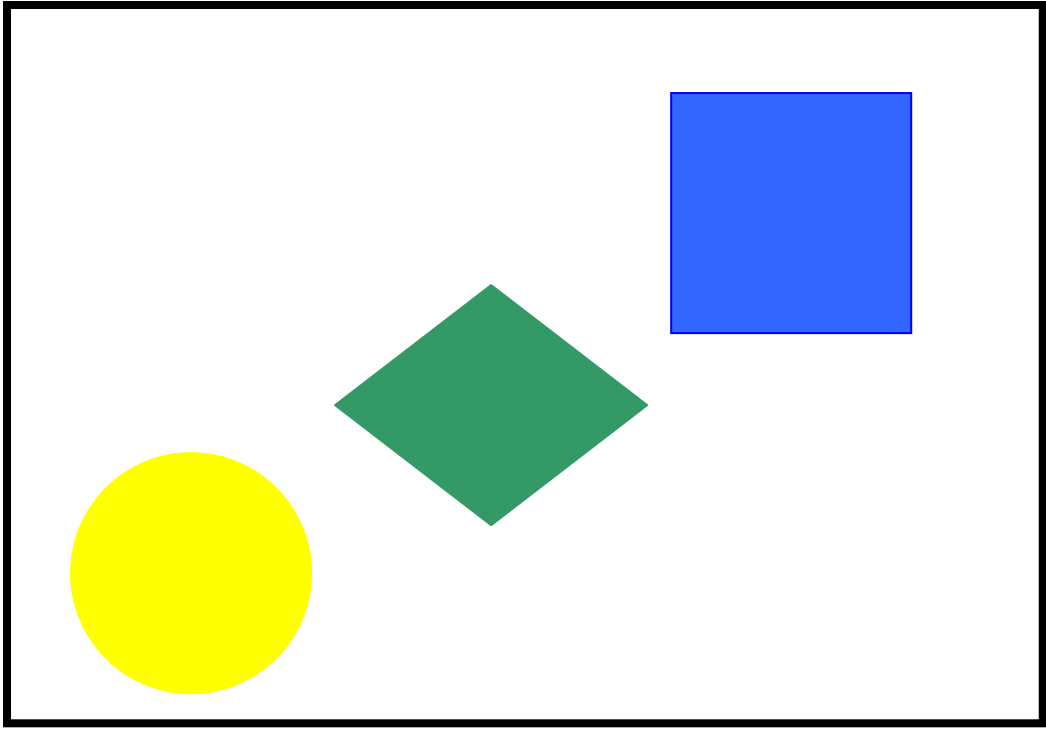

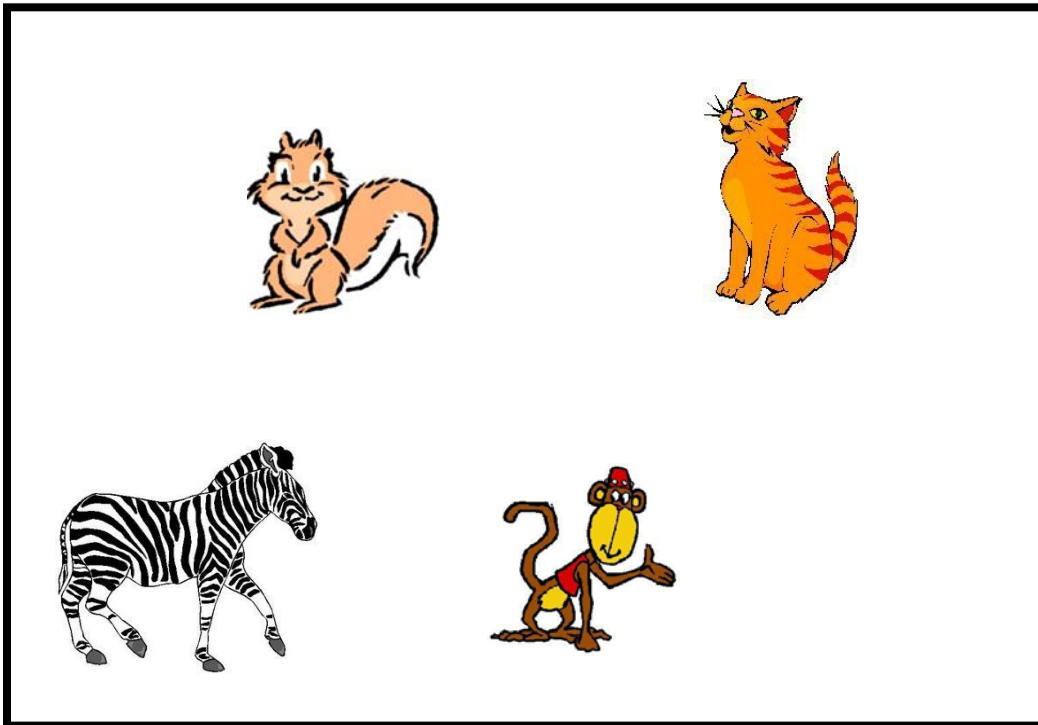
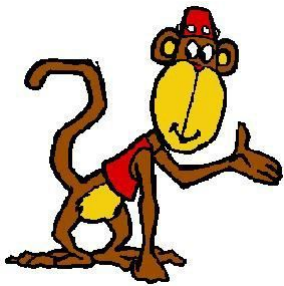
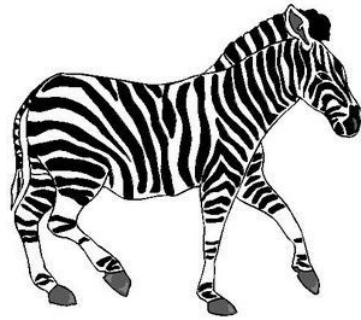

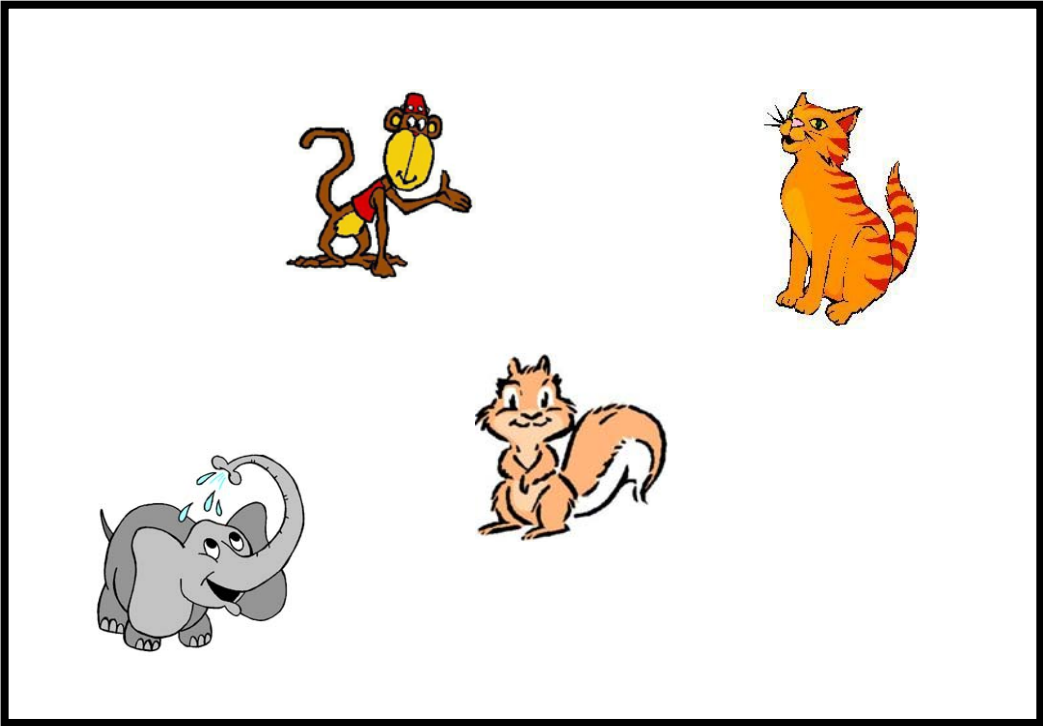
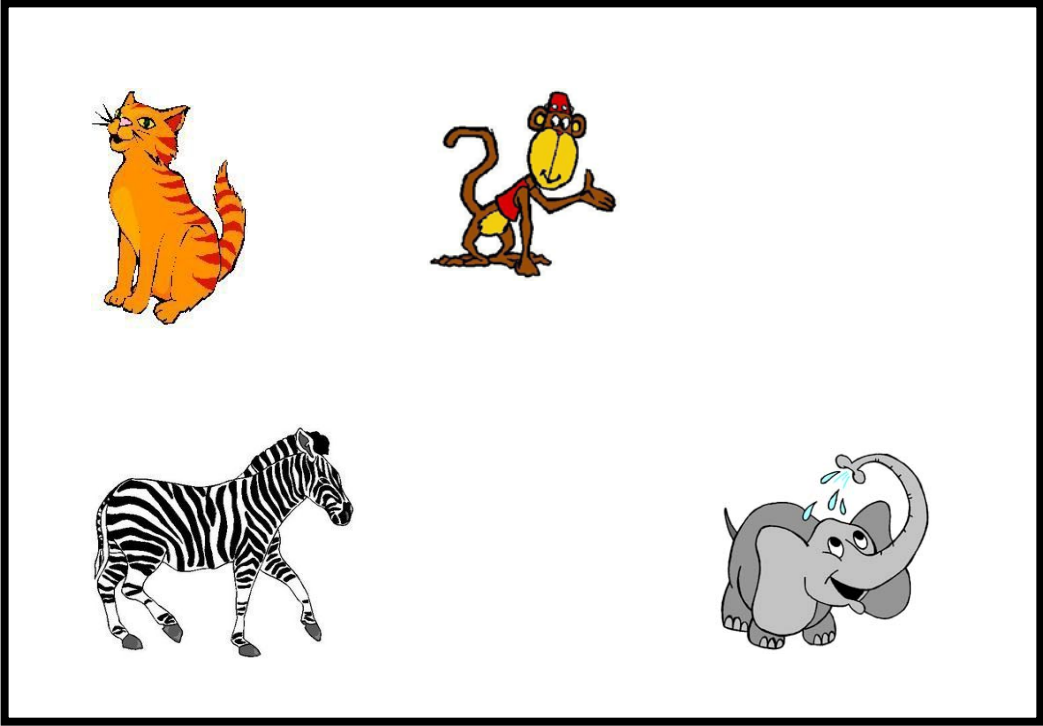

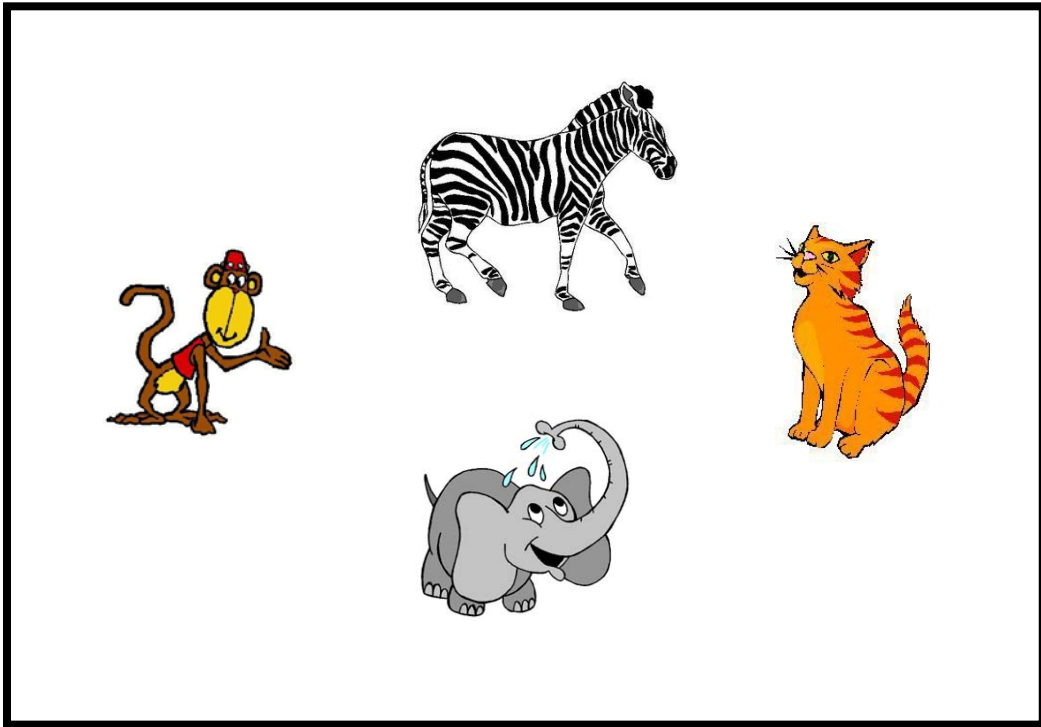
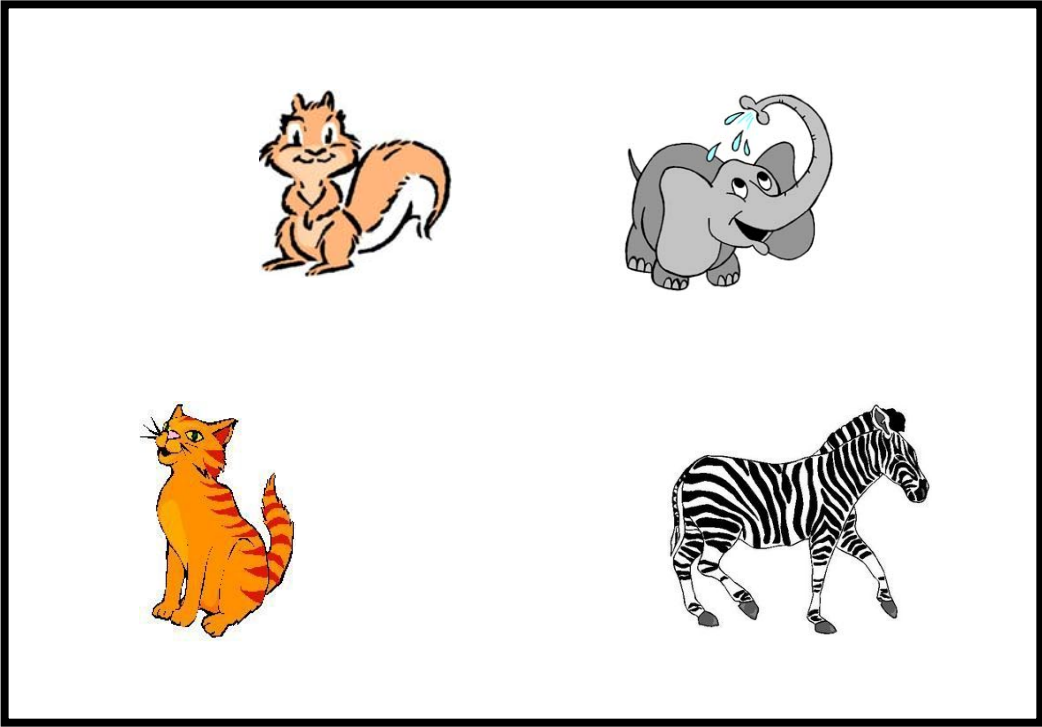

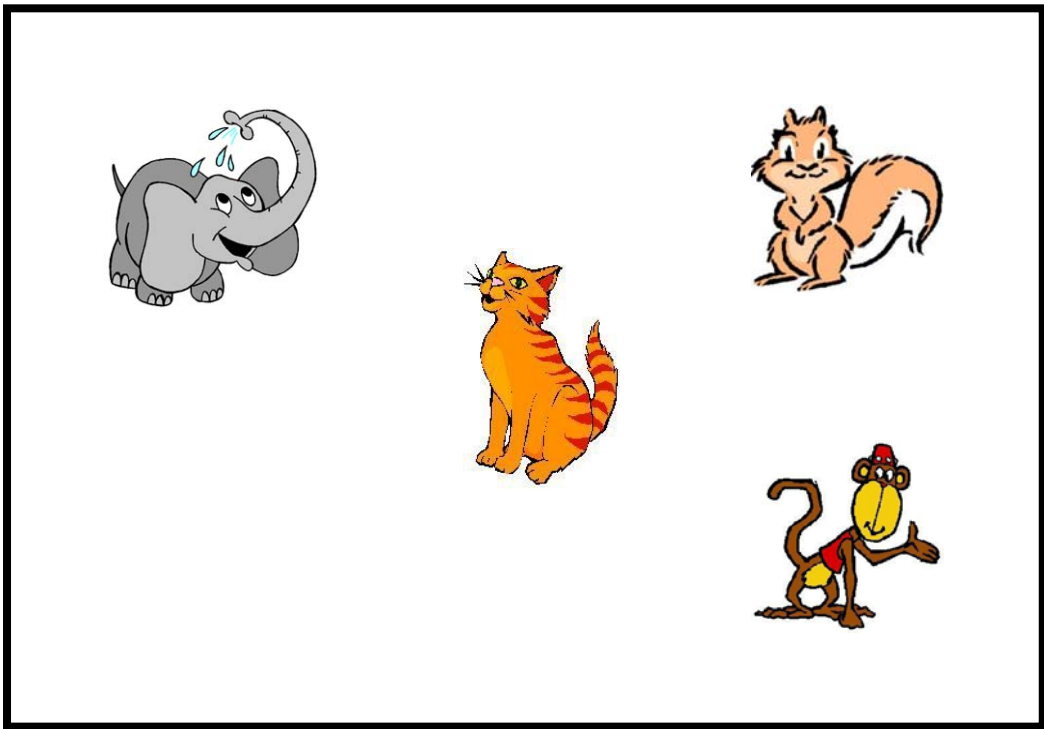
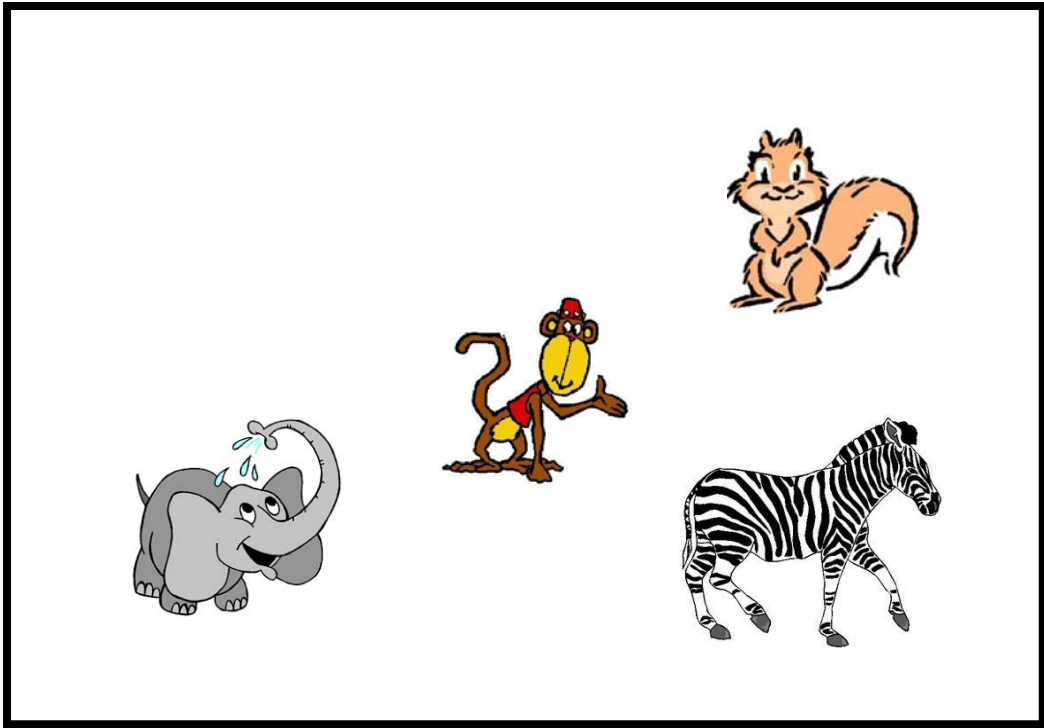

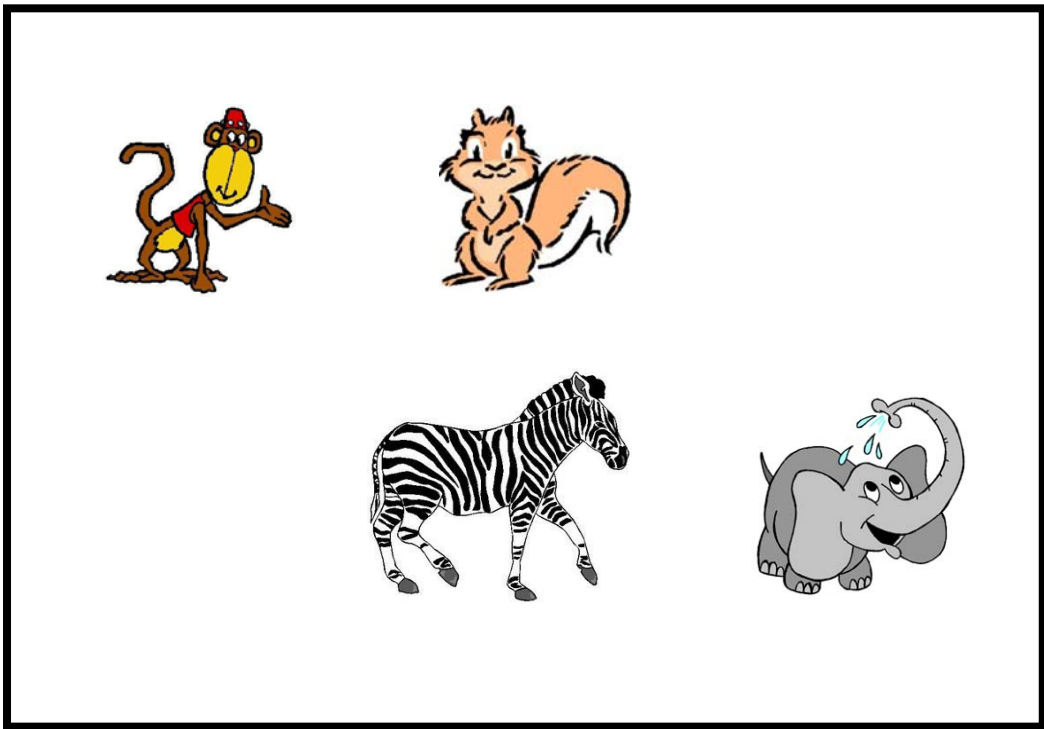
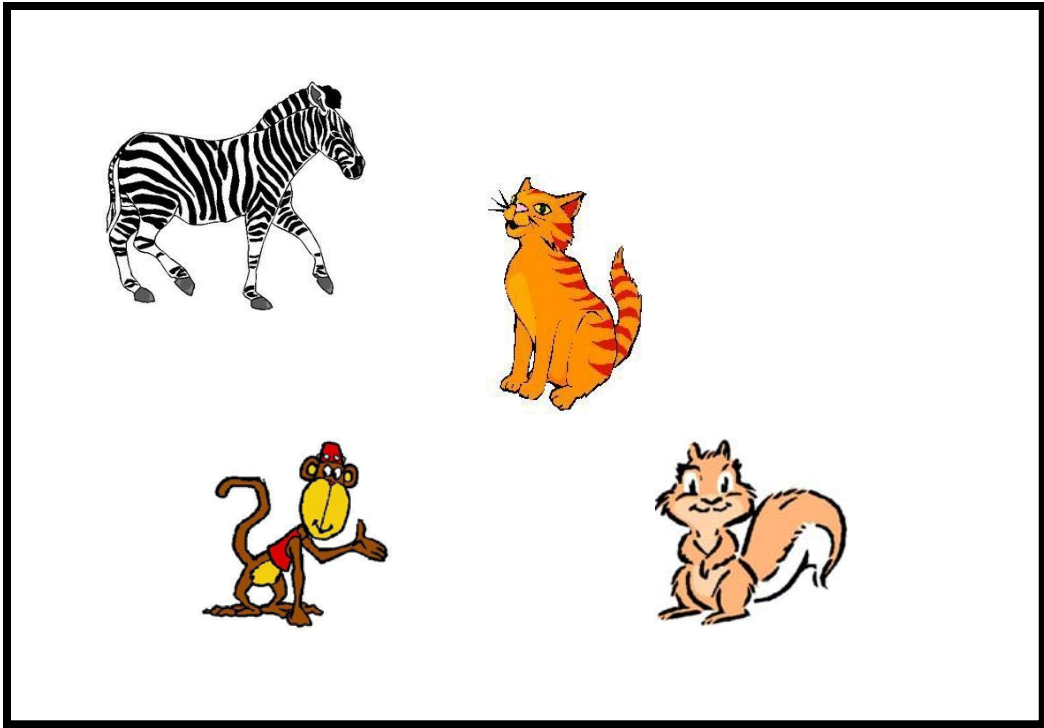



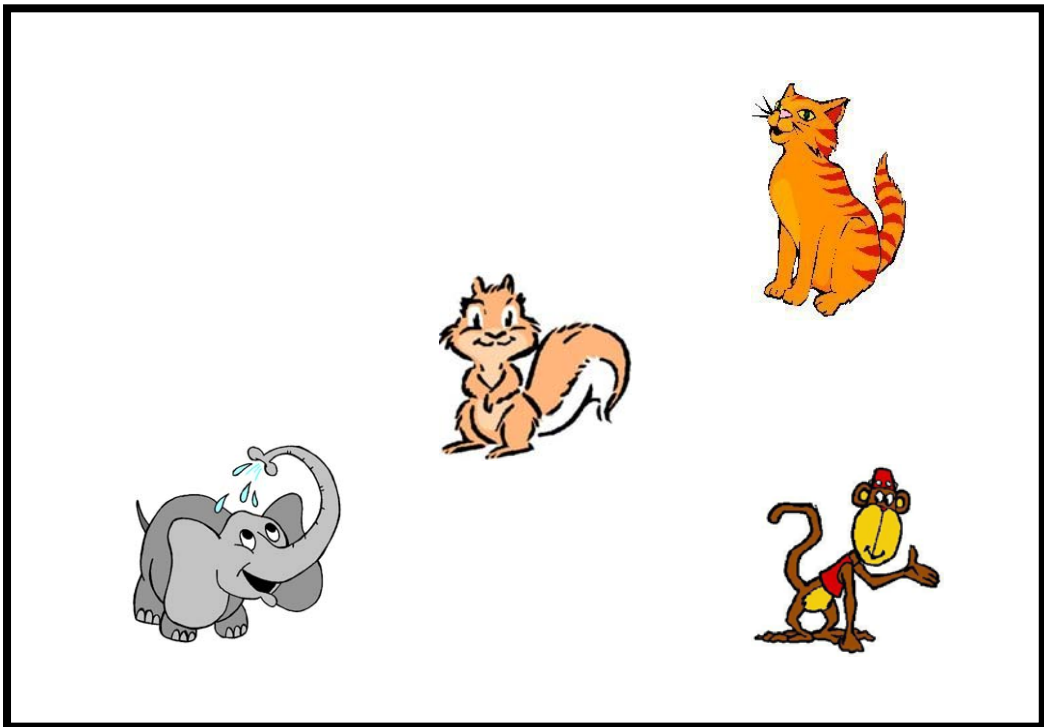
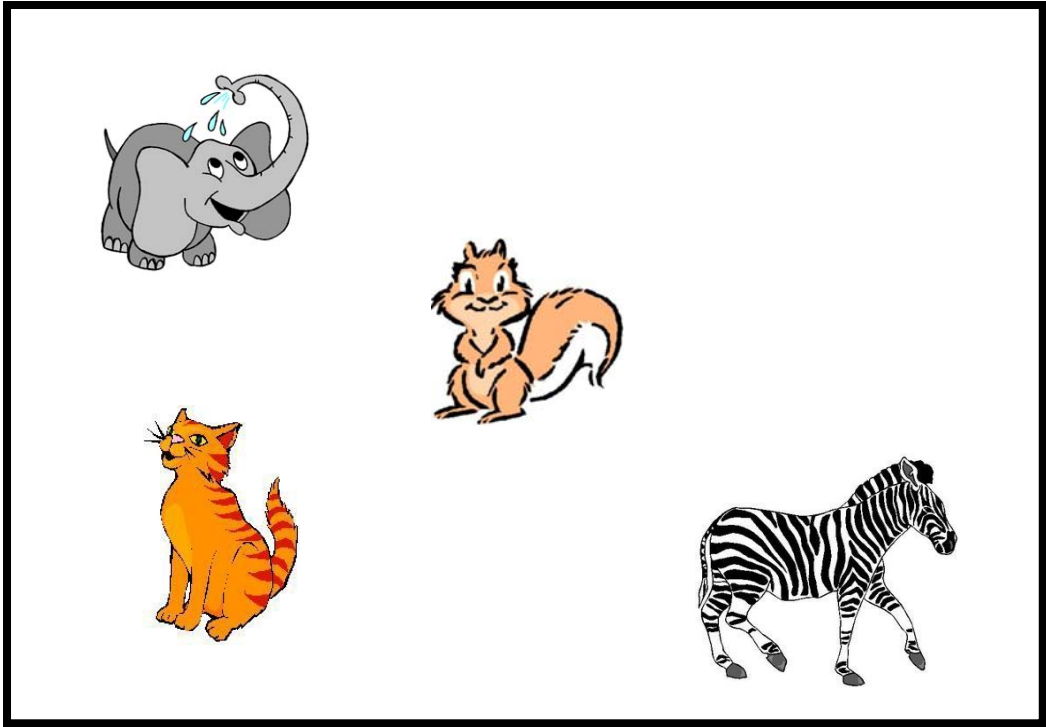

2

1

6

5

3

4

2

5

4

1

3

